

IC-3100 / IC-3100W / IC-3100P

User Manual

04-2012 / v1.0



COPYRIGHT

Copyright © Edimax Technology Co., Ltd. all rights reserved. No part of this publication may be reproduced, transmitted, transcribed, stored in a retrieval system, or translated into any language or computer language, in any form or by any means, electronic, mechanical, magnetic, optical, chemical, manual or otherwise, without the prior written permission from Edimax Technology Co., Ltd.

Edimax Technology Co., Ltd. makes no representations or warranties, either expressed or implied, with respect to the contents hereof and specifically disclaims any warranties, merchantability, or fitness for any particular purpose. Any software described in this manual is sold or licensed as is. Should the programs prove defective following their purchase, the buyer (and not this company, its distributor, or its dealer) assumes the entire cost of all necessary servicing, repair, and any incidental or consequential damages resulting from any defect in the software. Edimax Technology Co., Ltd. reserves the right to revise this publication and to make changes from time to time in the contents hereof without the obligation to notify any person of such revision or changes.

The product you have purchased and the setup screen may appear slightly different from those shown in this QIG. For more information about this product, please refer to the user manual on the CD-ROM. The software and specifications are subject to change without notice. Please visit our website www.edimax.com for updates. All brand and product names mentioned in this manual are trademarks and/or registered trademarks of their respective holders.

Notice According to GNU General Public License Version 2

This product includes software that is subject to the GNU General Public License version 2. The program is free software and distributed without any warranty of the author. We offer, valid for at least three years, to give you, for a charge no more than the costs of physically performing source distribution, a complete machine-readable copy of the corresponding source code.

The GNU GPL and GNU LGPL software codes used in Edimax products are distributed without any warranty and are subject to the copyrights of their respective authors. The firmware files for this product can be found under the “Download” page at the Edimax website (www.edimax.com).

Table of Contents

<i>Chapter I: Familiar with your Internet Network Camera</i>	4
1.1 Package Contents	4
1.2 Basic Introduction	5
1.3 Product Highlights	6
1.4 Key Components	7
1.5 Descriptions for LED Indicators.....	11
1.6 Camera Installation	12
1.7 Locate the IP Address of this Network Camera.....	13
1.8 Using the Camera Admin Software to Locate the Camera	17
2.1 Camera Settings	29
2.1.1 MJPEG.....	34
2.1.2 MPEG4	35
2.1.3 H.264.....	36
2.1.4 OSD.....	37
2.2.1 LAN.....	39
2.2.2 WLAN.....	42
2.2.3 Dynamic DNS	45
2.2.4 UPnP	46
2.2.5 LoginFree	48
2.2.6 RTSP	49
2.3 Motion Detection.....	50
2.3.1 Motion Detection	51
2.3.2 Motion Region	53
2.4 System Info.....	60
2.4.1 Camera Information	61
2.4.2 Date / Time Setting.....	62
2.4.4 Utilities.....	65
2.5 Account.....	67
2.6.1 Status.....	70
2.6.2 Space Alarm	71
2.6.3 File Management	73
<i>Chapter III: Using Surveillance Software</i>	74
3-1 Installing Network Camera Surveillance Software	74
3-2 Using Network Camera surveillance software.....	78
3-3 Configure Network Camera surveillance software.....	81

3-3-1 Configure cameras	81
3-3-2 General Settings	90
3-4 Change Display Layout	96
3-5 Full-screen mode.....	99
3-6 Scan.....	100
3-7 Zoom-in / Zoom-out	101
3-8 PTZ.....	102
3-9 Snapshot.....	103
3-10 Recording	104
3-11 Video Playback	105
<i>Chapter IV: How to Access the Network Camera Remotely with iPhone &</i>	
<i>Android Phones</i>	<i>106</i>
4.1 iPhone App Installation	109
4.2 Android App installation	120
4.3 Web browser installation	135
<i>Chapter V: Appendix.....</i>	<i>140</i>
5.1 Specifications	140
5.2 How to apply for a free DNS account at http://www.no-ip.com	141
5.3 Troubleshooting	143

Chapter I: Familiar with your Internet Network Camera

1.1 Package Contents

Thank you for purchasing this Network Camera! Before you start to use this Network Camera, please check the package contents. If anything is missing, please contact the dealer of purchase and return the package to claim for missing contents.

	Item Name	Quantity
1	Network Camera	1
2	Antenna(wireless model only)	1
3	Power Adapter	1
4	Ethernet Cable	1
5	Driver and User Manual CD-ROM	1
6	Accessory kit	1
7	Quick Installation Guide	1

System Requirements

- Computer with Windows® 7, Vista or XP
- PC with dual core or above; at least 2GB RAM
- Internet Explorer 6.0 above
- Existing 10/100 Ethernet-based network or wireless 802.11b/g/n network(for wireless model only)

1.2 Basic Introduction

Thank you for purchasing this Network camera! This Network camera is an ideal product for all kinds of video surveillance purposes, like home/office safety, kid/pet monitoring, and remote video acquire etc. Edimax IC-3100 series is tailor made to stream live video over your network. You can view the Network camera's video from anywhere on your local computers or via the Internet. Besides, Edimax IC-3100 series features high quality and high frame rate video streaming through advanced video compression. In order to achieve the highest video quality, simply select H.264, MPEG4 or M-JPEG depending on your network settings.

You can discover more useful functions in next section!

1.3 Product Highlights

- ✚ No pre-loaded software required - all you need is a browser like Internet Explorer 6 (and above, with plugin installed).
- ✚ With supplied video surveillance software, you can connect up to 16 video cameras and view images captured by every camera at the same time.
- ✚ Supports 3 video resolutions: MJPG and H.264 SXGA(1280 x 1024), VGA (640 x 480), and QVGA (320 x 240); MPEG4 XGA (1024 x 768), VGA (640 x 480), and QVGA (320 x 240).
- ✚ Anti-flicker function (eliminates flash caused by fluorescent lights, 50 / 60Hz selectable).
- ✚ Supports all major web browser, including Microsoft Internet Explorer, Apple Safari, Google Chrome, Firefox, and Opera*.
- ✚ Audio function, suitable for applications like video conference or environment monitor.
- ✚ Wired and wireless network (802.11b / 802.11g / 802.11n) support, supports up to 100Mbps for wired network and 100Mbps for wireless network.
- ✚ Wireless data encryption (WEP / WPA)
- ✚ Supports DHCP and PPPoE protocol, you can also assign a fixed IP address to the camera also.
- ✚ Supports Dynamic DNS (used to allocate the Network Camera's Internet address, when the ISP you're using does not assign you with a fixed Internet address).
- ✚ Supports UPnP, Windows XP (and above) will discover this Network Camera in network neighbor automatically.
- ✚ Send captured picture and video by Email or FTP when motion is detected.
- ✚ Configurable motion detection sensitivity (6 levels from most sensitive to least sensitive).
- ✚ Built-in real-time clock, date and time information will be recorded with every captured picture / video clip (also supports auto time synchronization via network time protocol).
- ✚ Upgradeable firmware.
- ✚ Supports up to 16 users, and you can set different password to different user.
- ✚ Usage and event logging.

*Some functionality like 'fit to window' only works on Microsoft Internet Explorer.

1.4 Key Components

Front View

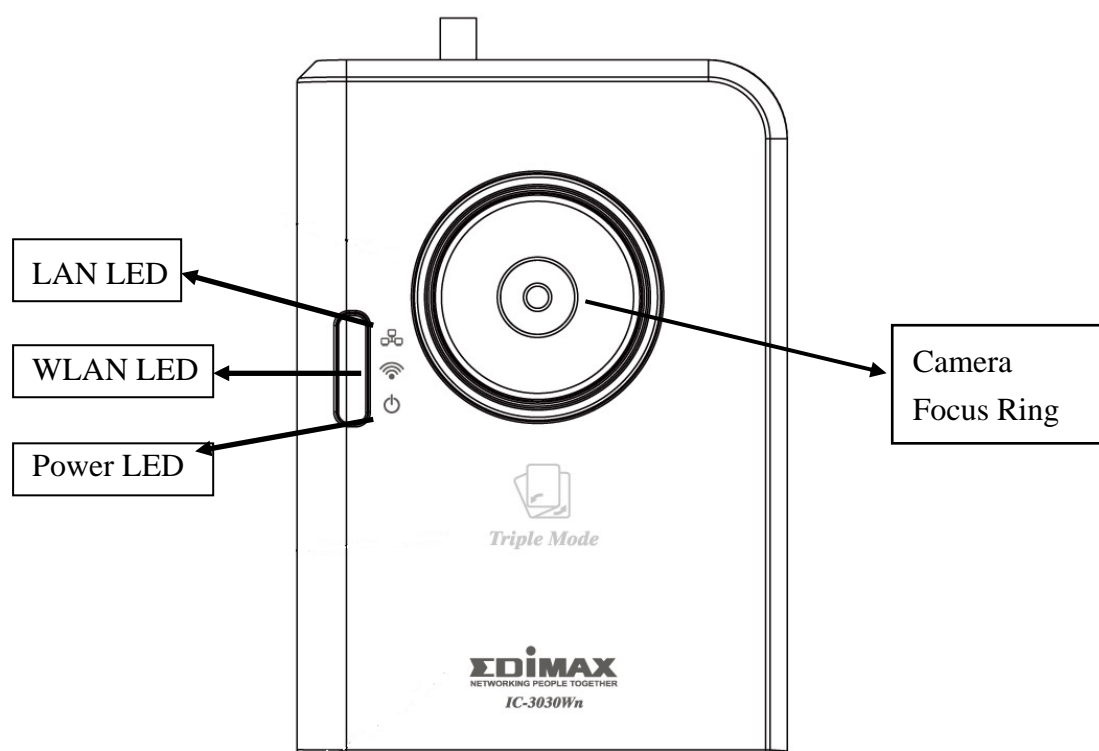

LAN LED: Indicates LAN activity

WLAN LED: Indicates Wireless LAN activity (only work on wired model plugged with USB WiFi dongle and wireless model)

Power LED: Indicates power status

Focus Ring: Adjusts focus

Top View

Wired model

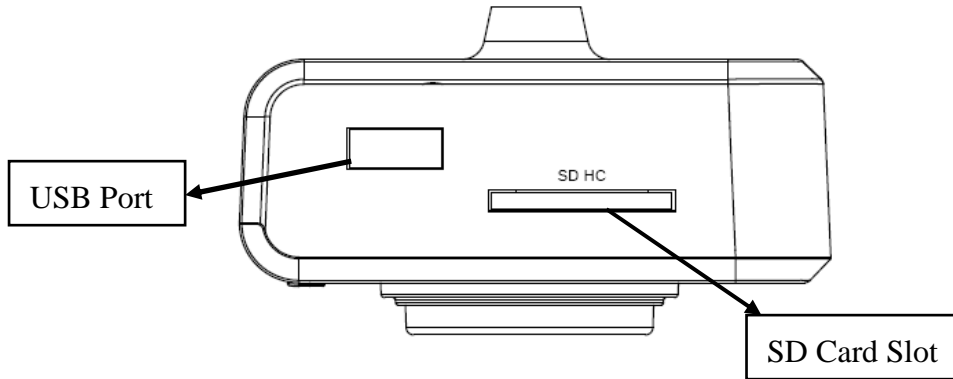

POE model

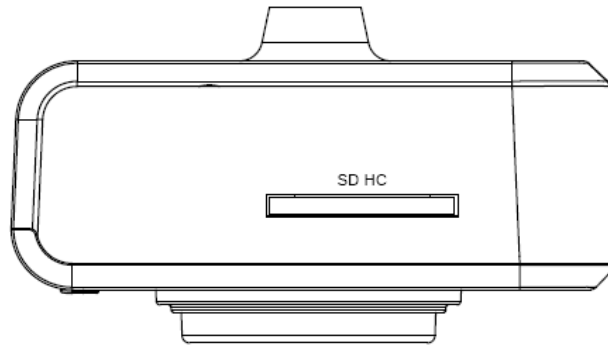

Wireless model

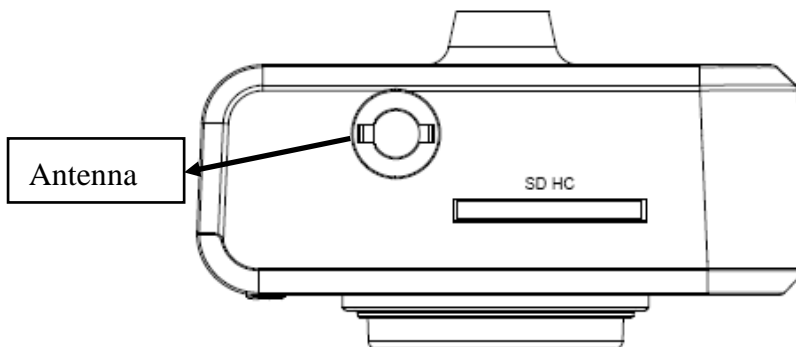

SD Card Slot: Accepts SD / SD-HC memory card for image / video storage

USB Port: Connects to certain wireless module.

Antenna Base: Connects to supplied antenna

Bottom View

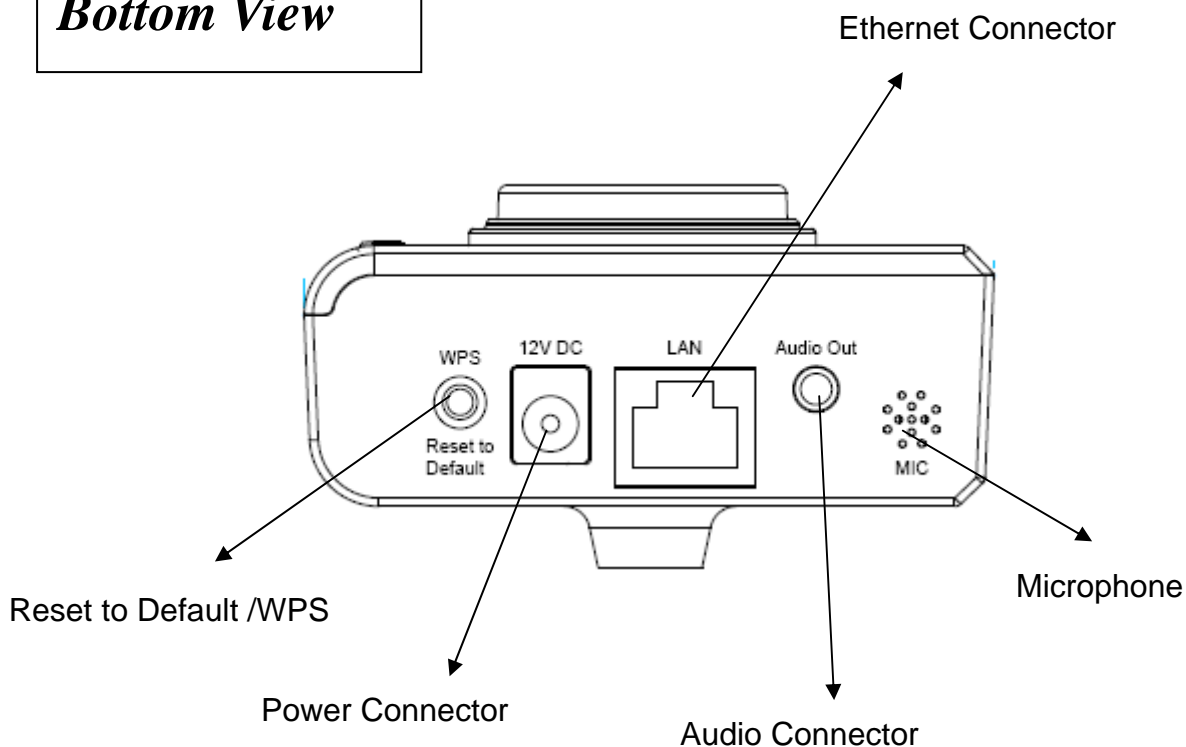

WPS: click the button on IP Cam and click it on the AP you want to connect wireless connection.(works on wired model with USB wifi dongle plugged or wireless model)

Reset to Default Button: Press and hold for more than 10 seconds to reset the camera settings to factory default value.

Power Connector: Connects to 12V DC power adapter

Ethernet Connector: Connect to your local area network

Audio Connector: Connects to external speaker for audio output

Microphone: Built-in microphone for voice pick-up

Back View

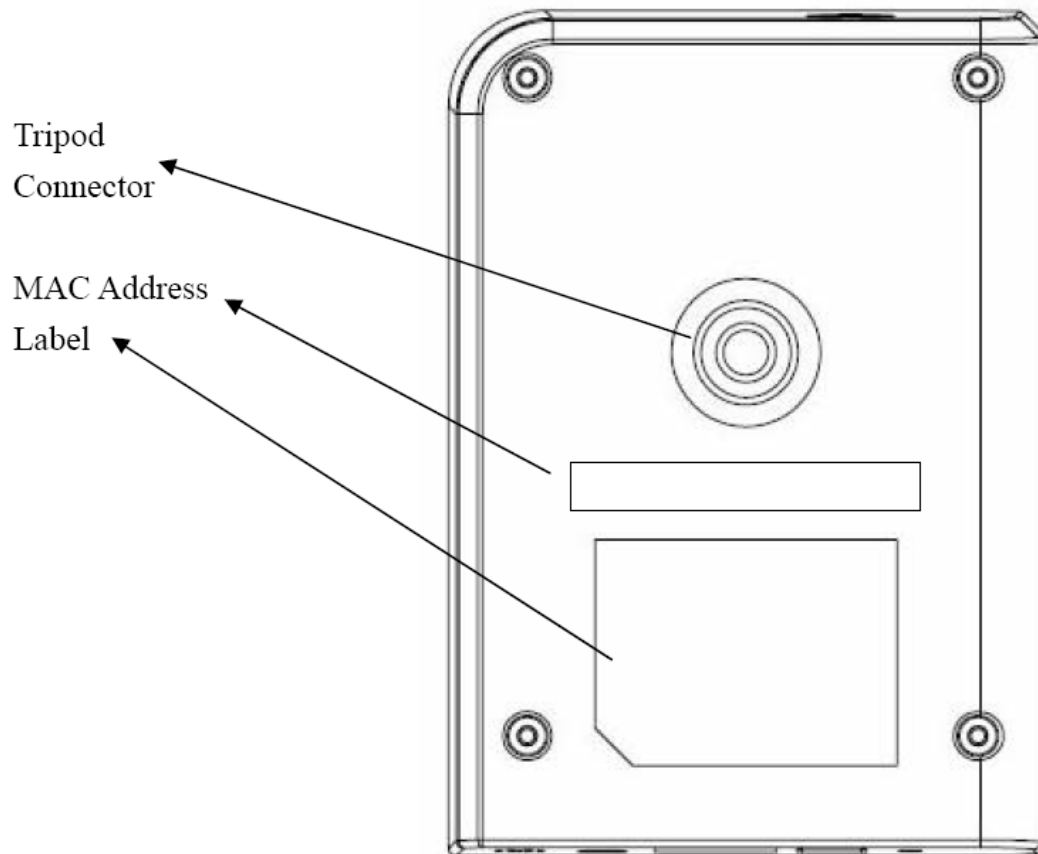

Tripod Connector: Connects to any standard tripod / camera wall holder.

MAC Address Label: Shows the MAC address of this Network Camera. Useful when you can't locate the camera on the network.

1.5 Descriptions for LED Indicators

LED Name	Status	Description
Power/Cloud	Off	Camera is not powered (camera off)
	On	Camera is correctly powered (camera on)
	Flash	The power LED will flash and light up when the camera is powered on and ready for access to Cloud.
LAN	Off	LAN port not in use
	On	LAN port in use
	Flash	Transferring data via LAN port
WLAN	Off	Wireless LAN not in use
	On	Wireless LAN in use
	Flash at low speed	Waiting for WPS connection from AP and flash speed is once a second.
	Flash	Transferring data via wireless LAN

1.6 Camera Installation

Please follow the following instructions to set your Network Camera up.

1. Unpack the product package and check if anything's missing.
2. Connect the Ethernet cable to your local area network, and connect the other end to the LAN jack of this Network Camera.
NOTE: *You can skip this step if you plan to use wireless LAN only.*
3. Plug the power adapter to wall socket, and connect the power connector to the power jack located at the bottom of the Network Camera.
4. Connect two antennas to the antenna bases, which is located at the back of this Network Camera.
5. Place the camera at a secure place, and point the camera to the place you wish to monitor. If you wish to hang the camera on the ceiling or wall, please use the tripod connector (located at the bottom of the camera) to secure the camera.
6. Launch Internet Explorer on your computer, and following the instructions given in next section to set the Network Camera.

1.7 Locate the IP Address of this Network Camera

Default IP address of this Network Camera is 192.168.2.3. If you wish to assign another IP address to this Network Camera, you have to log onto the web configuration interface of the camera first.

If the left three fields of the IP address of your computer is not 192.168.2, you'll have to change the IP address of your computer first:

1. Click 'Start' -> 'Control Panel'

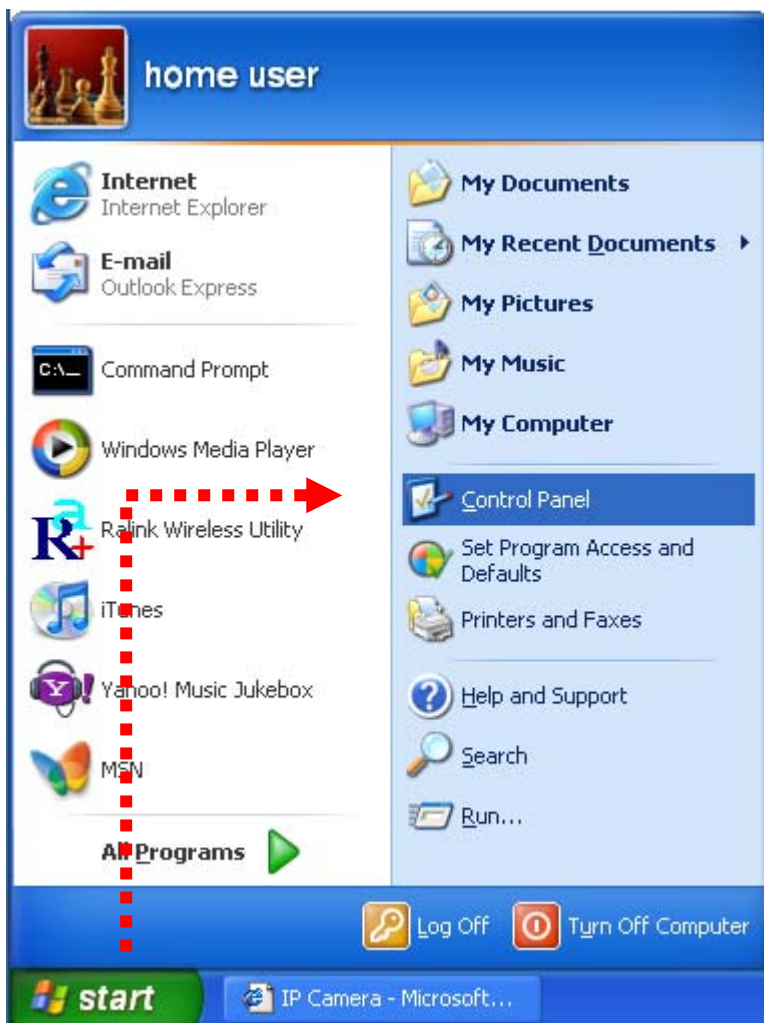

2. Double-click 'Network Connections' icon.

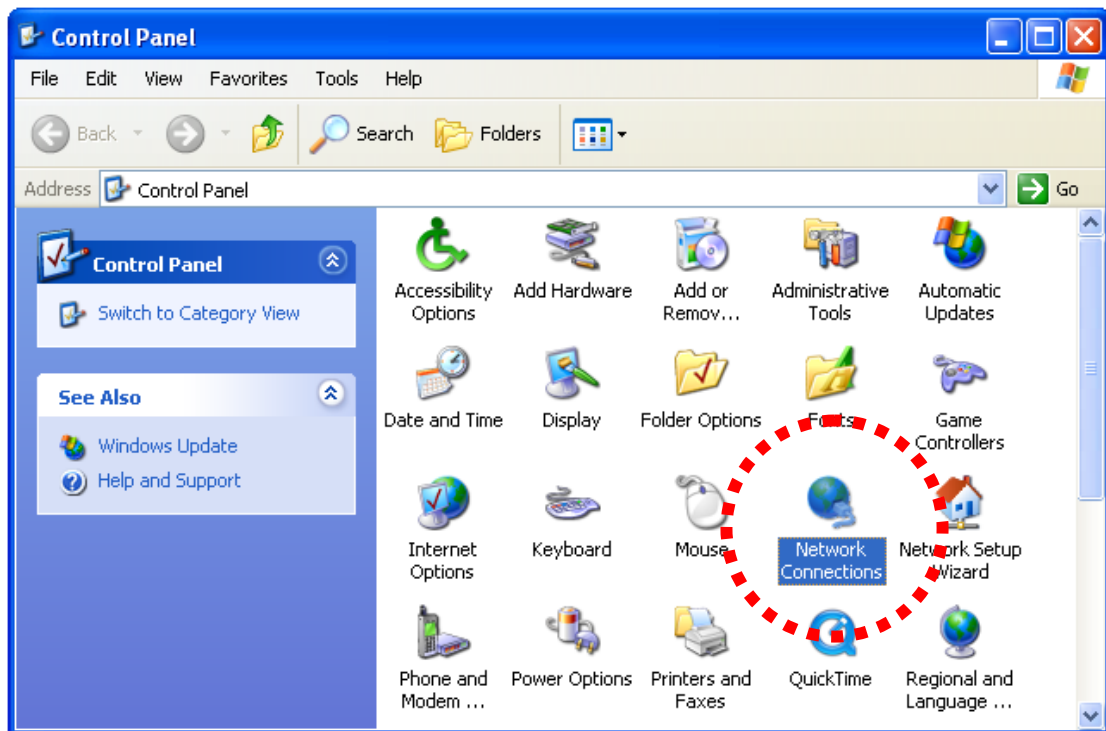

3. Right-click 'Local Area Connection', and click 'Properties'.

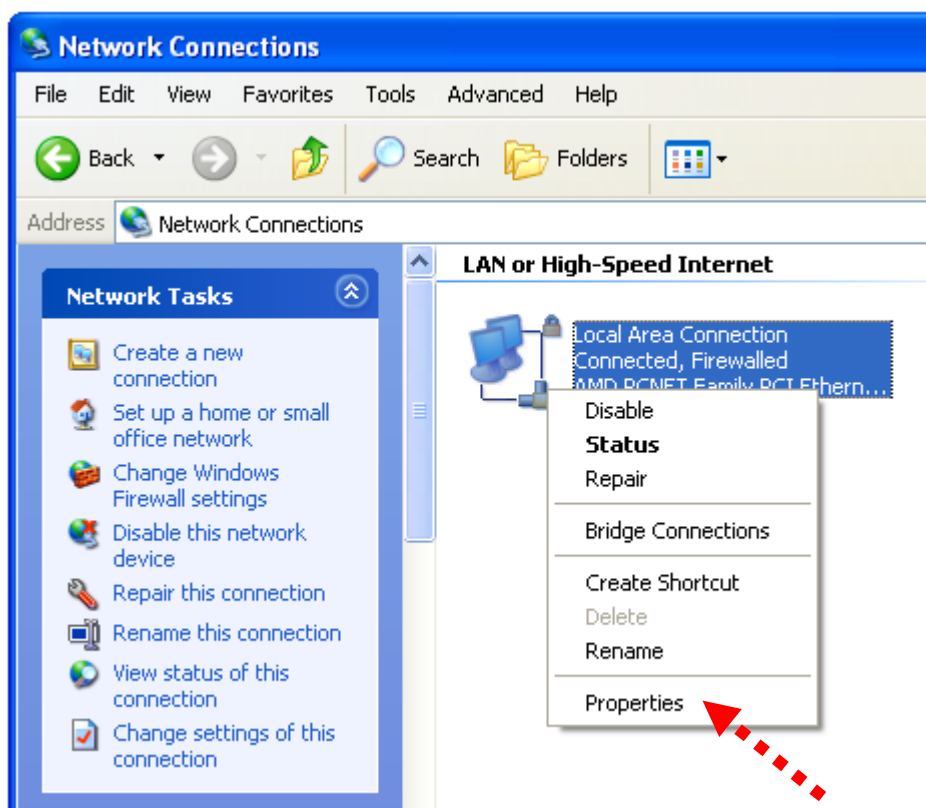

4. Select 'Internet Protocol (TCP/IP)', then click 'Properties'.

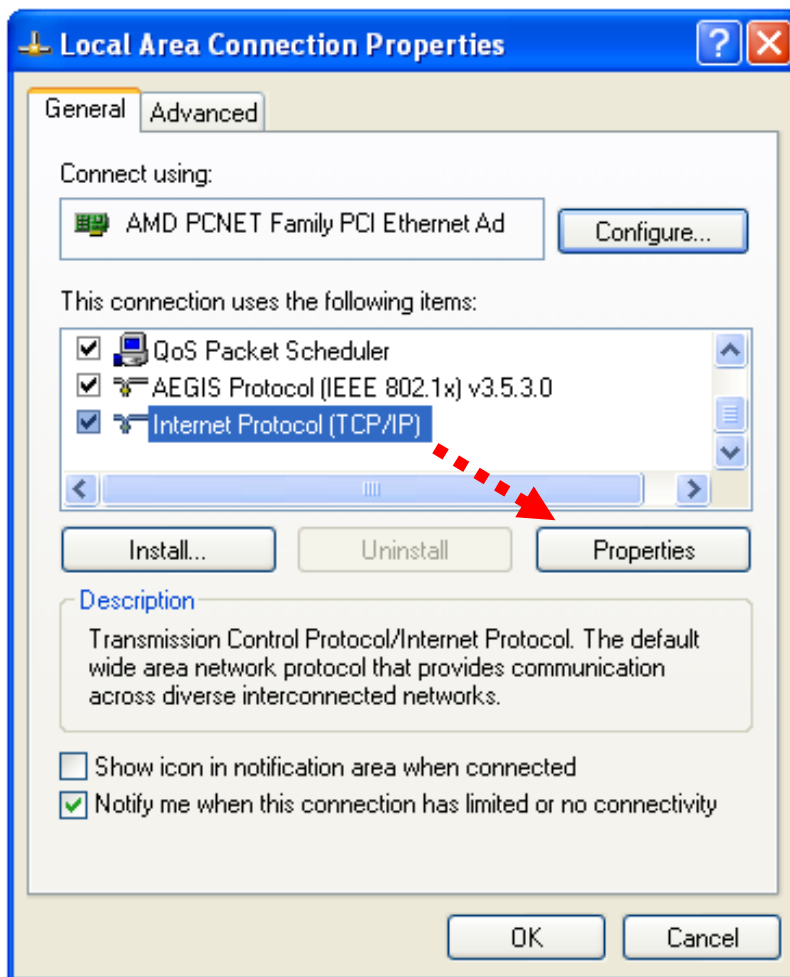

5. In 'IP address' field, please fill in any IP address begins with '192.168.2', and ends with a value greater than 2 and less than 254 (You can use the example in the picture '192.168.2.339'). In Subnet mask field, please fill '255.255.255.0'. Please keep all other fields empty, and click 'OK'.

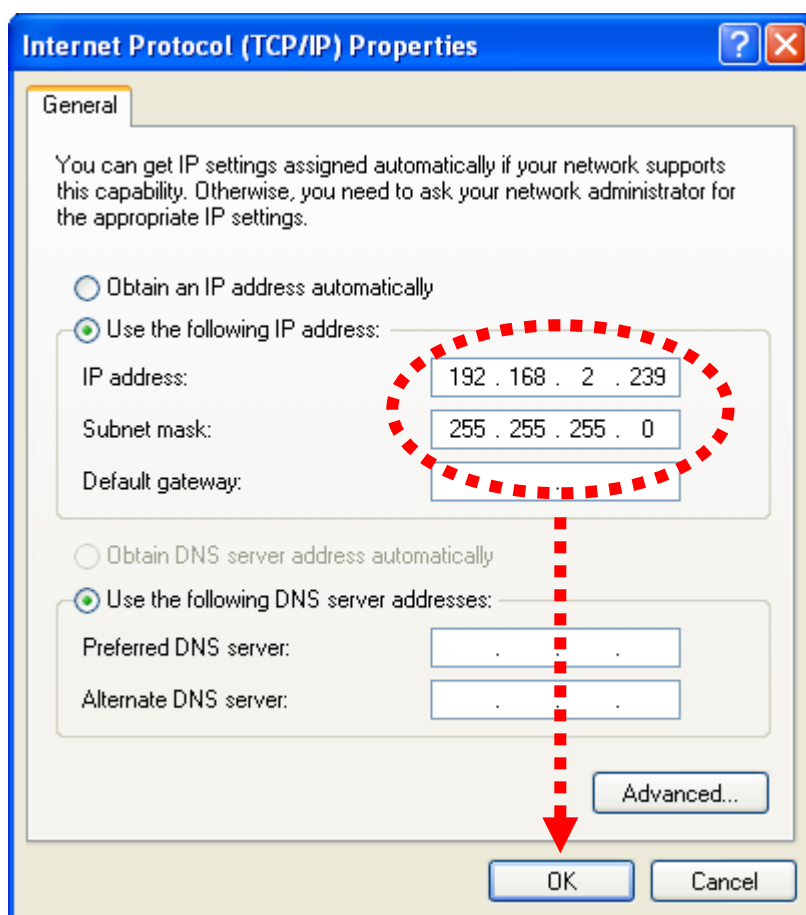

If you changed the IP address of this Network Camera and you forget it, there're 2 methods to recover it:

- a. Press and hold the 'Reset' button located at the bottom of this Network Camera, to clear all settings of the Network Camera and reset the IP address back to 192.168.2.3. You'll lose all settings in the Network Camera.
- b. Ask network administrator to check the DHCP release table, if the camera was set to obtain the IP address by DHCP, a new record will be added to DHCP release table on DHCP server when the Network Camera is connected to the local area network.

1.8 Using the Camera Admin Software to Locate the Camera

If you can't connect to the camera by the instructions given in last chapter, you can use camera admin software to search the camera which is connected to your local area network. The admin software is also capable to locate multiple cameras on your local area network.

Please insert the user manual CD-ROM supplied in the product package, and the CD will automatically running the installation, if not please double-click 'EdiView Finder utility_v1.0.5' icon :'.

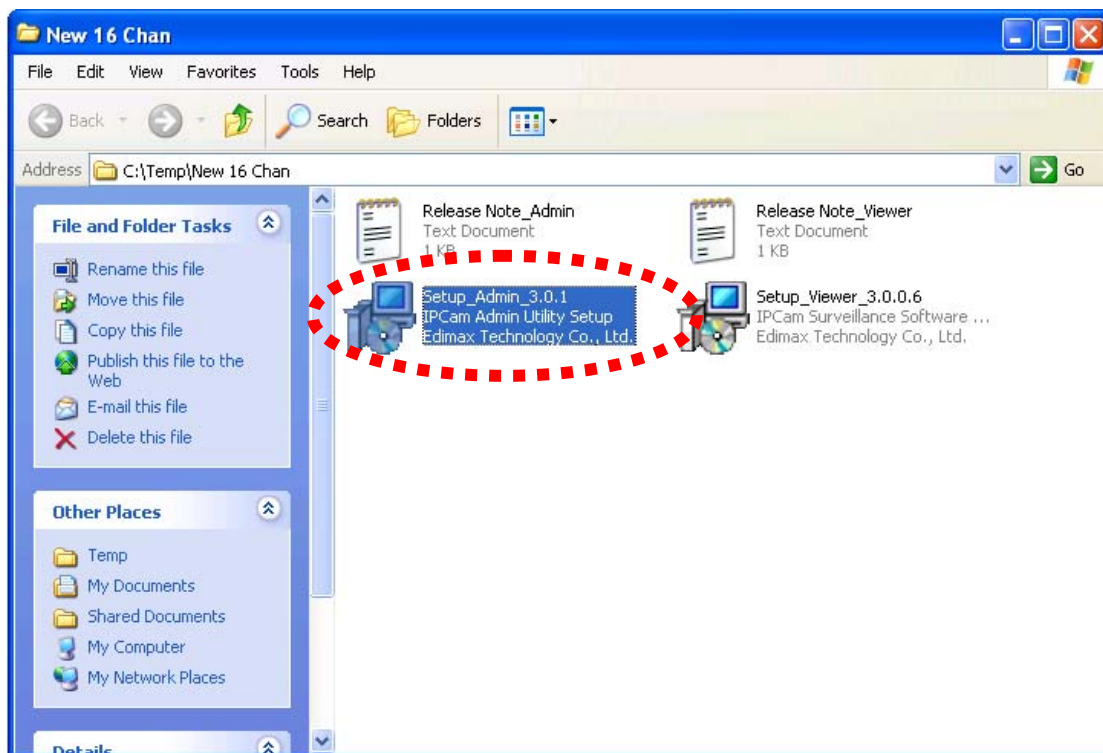

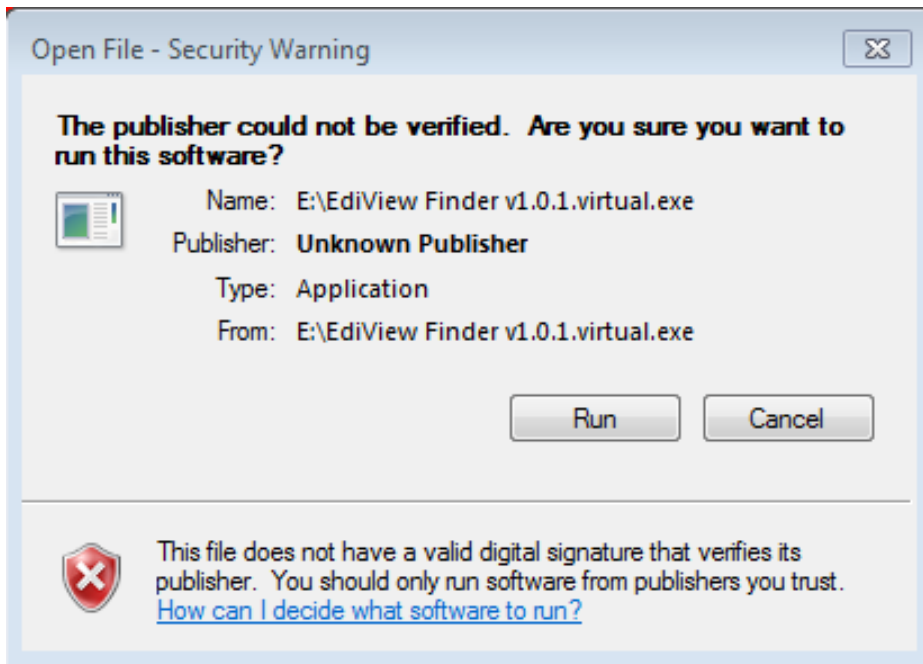

Then follow the following instructions to install and use camera admin software:

1. Double-click Ediview finder installer, and click 'Run' when you're prompted:



2. Ediview finder will list all Ediamx network cameras found on local network, with their IP address and MAC address:

You can click  icon to find network cameras on local network again, or select an network camera and click  Icon to configure it (see next step).

To preview the image of network camera, please click the icon indicated by white arrow, and provide username / password, and a snapshot will be displayed.

This function is only available when this icon is displayed as blue color.

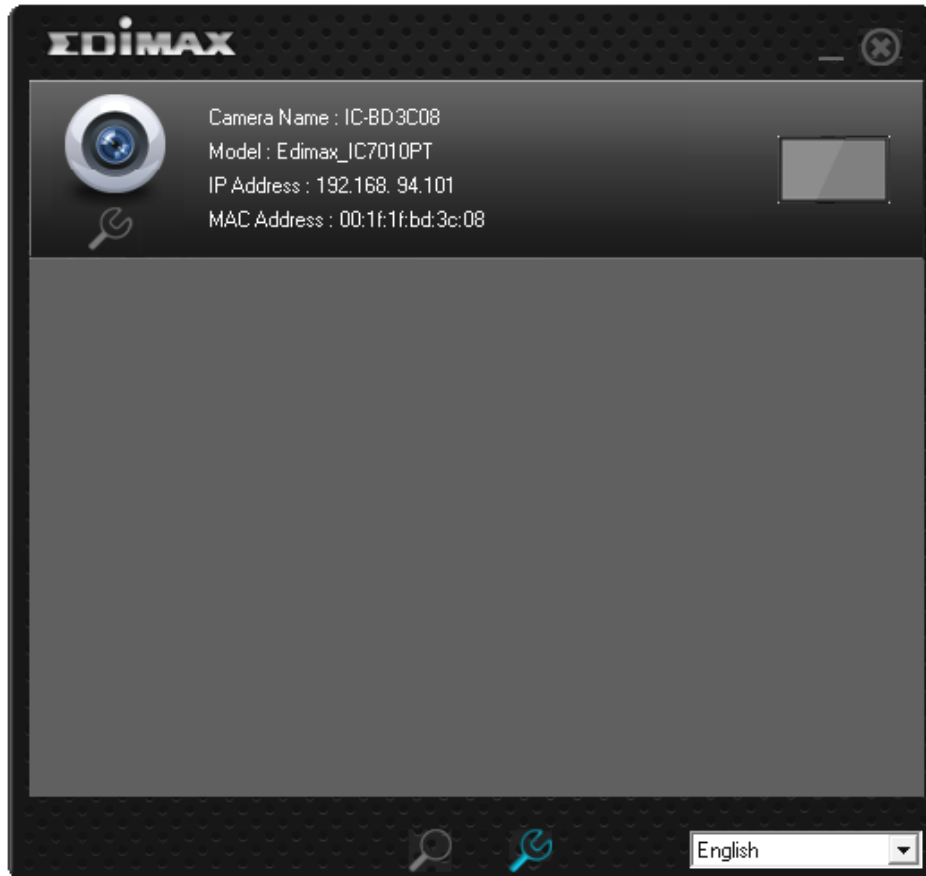

3. Ediview finder will inspect network camera's connection type and if it's connected to Internet, this may take a few seconds, please be patient

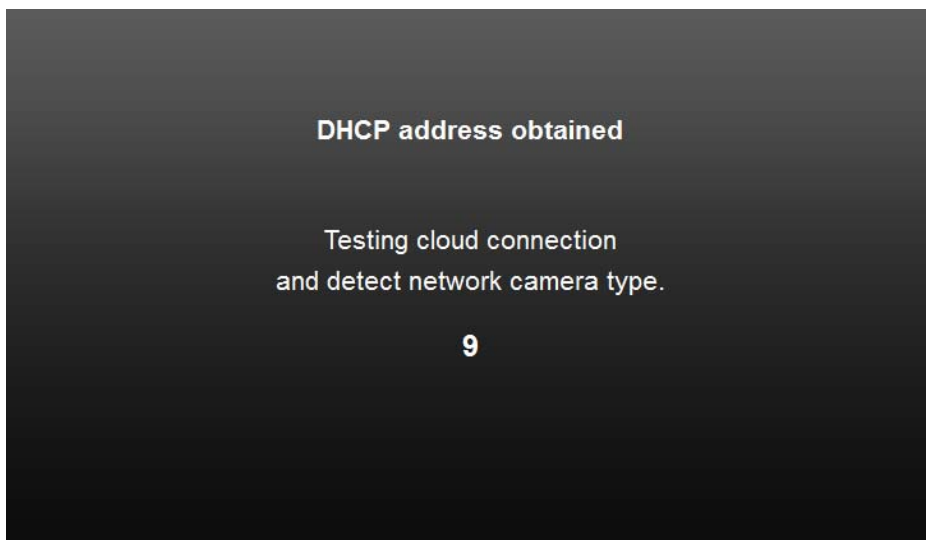

4. This message will tell you if your network camera is connected to Internet (connected to the cloud), and the connection type (wired or wireless). When you see this message, click 'Next' to continue. If you don't want to change network camera's name and password, you can click 'X' on the upper-right corner of window to close ediview finder utility

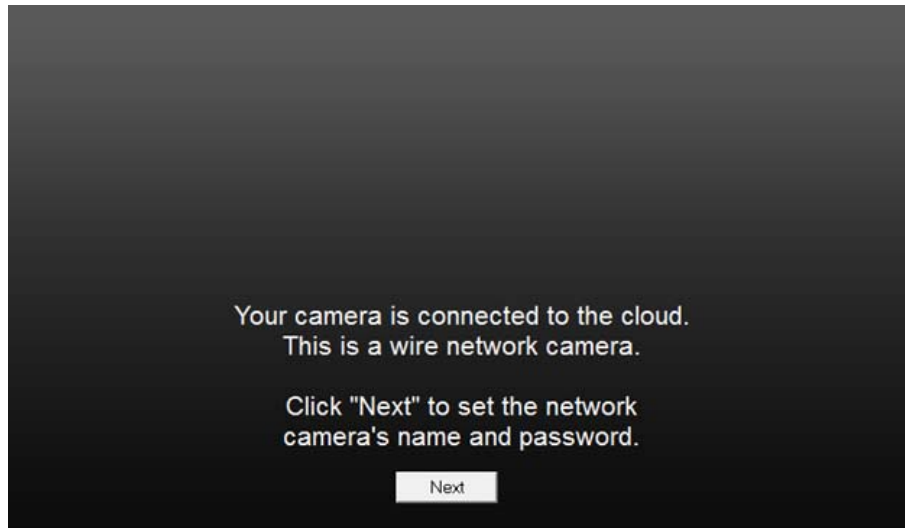

5. You can input these information to configure network camera. Camera Name: Input network camera's name used to identify this network camera. Password: Input new password Confirm: Input new password again for confirmation Click 'OK' button to keep changes

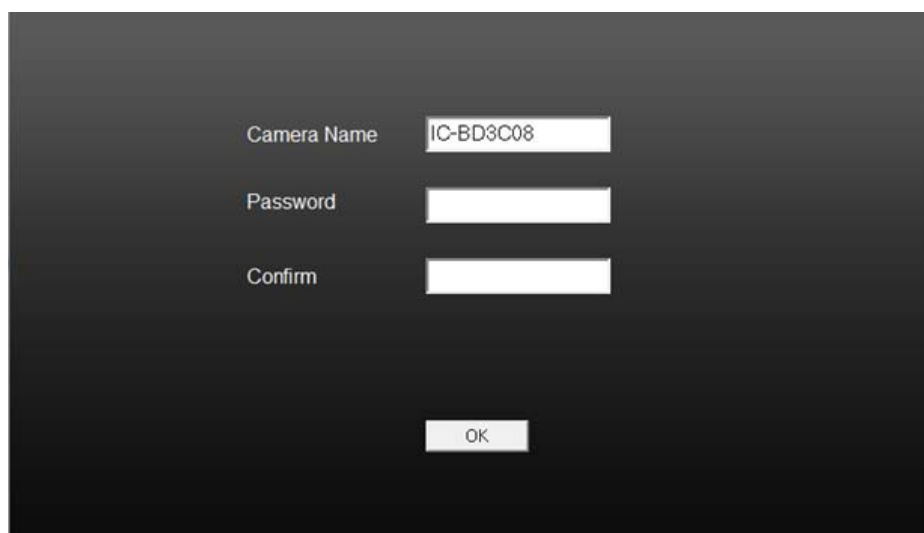

After the camera finder utility is launched, all cameras found on your local area network will be displayed. To preview the image of network camera, please click the icon indicated by white arrow, and provide username / password, and a snapshot will be displayed

This function is only available when this icon is displayed as blue color.

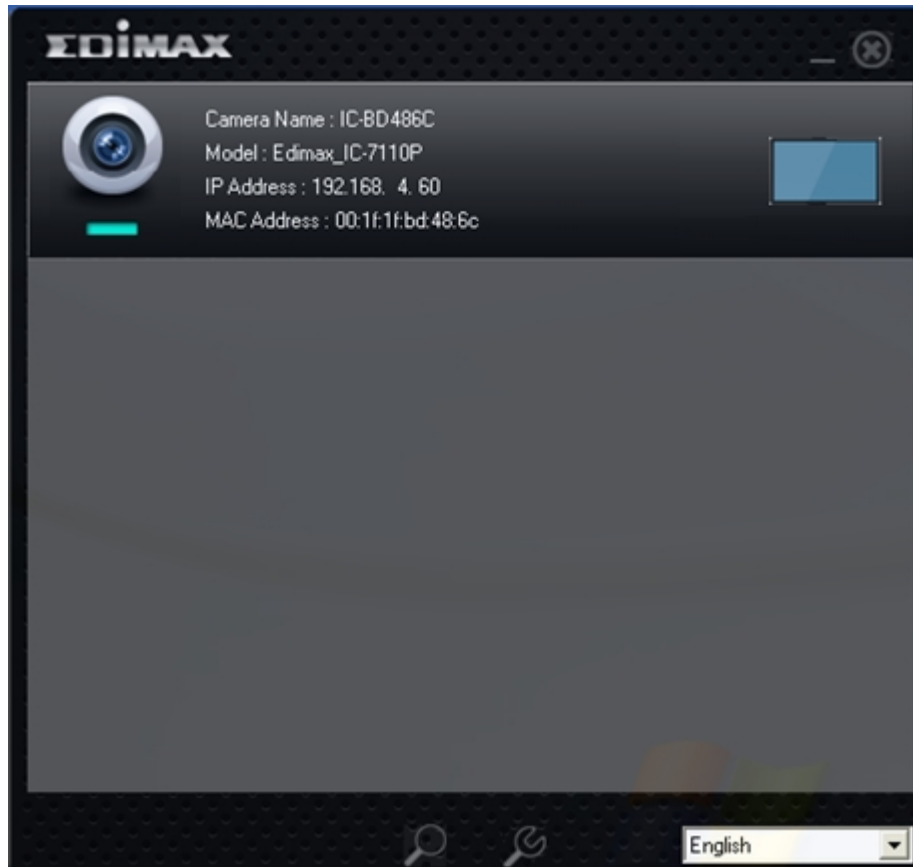

All camera-related information will be displayed here. If you wish to connect to certain camera by web browser, double-click the camera listed here.

The camera admin software also provides several functions:

Language change: This camera finder utility supports 3 languages: English, Chinese, and Simplified Chinese. You can select the language you wish to use from language dropdown menu located at upper-right corner of camera finder utility.

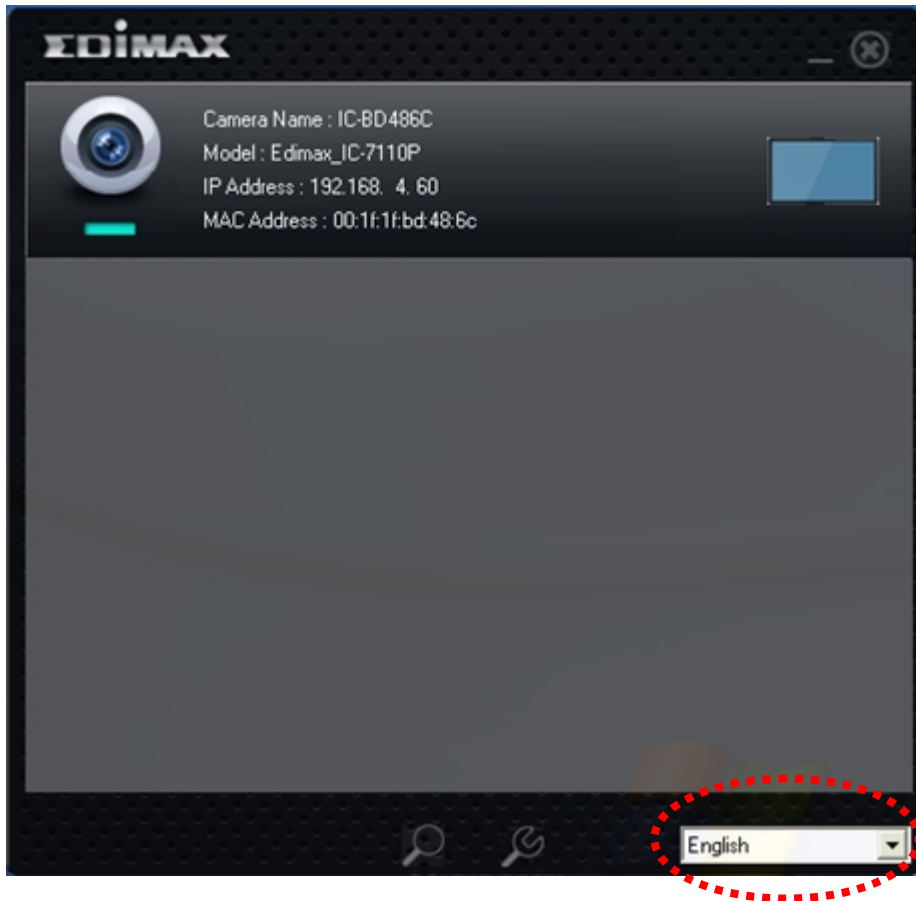

Search camera: Click this button to search all cameras on local area network again.



Configure camera: Click this button to configure camera's network and security setting. You'll be prompted to input camera's password:

Camera Name	<input type="text" value="IC-BD3C08"/>
Password	<input type="password"/>
Confirm	<input type="password"/>
<input type="button" value="OK"/>	

Input the password (default: 1234) and click OK to configure the camera's network and security setting:

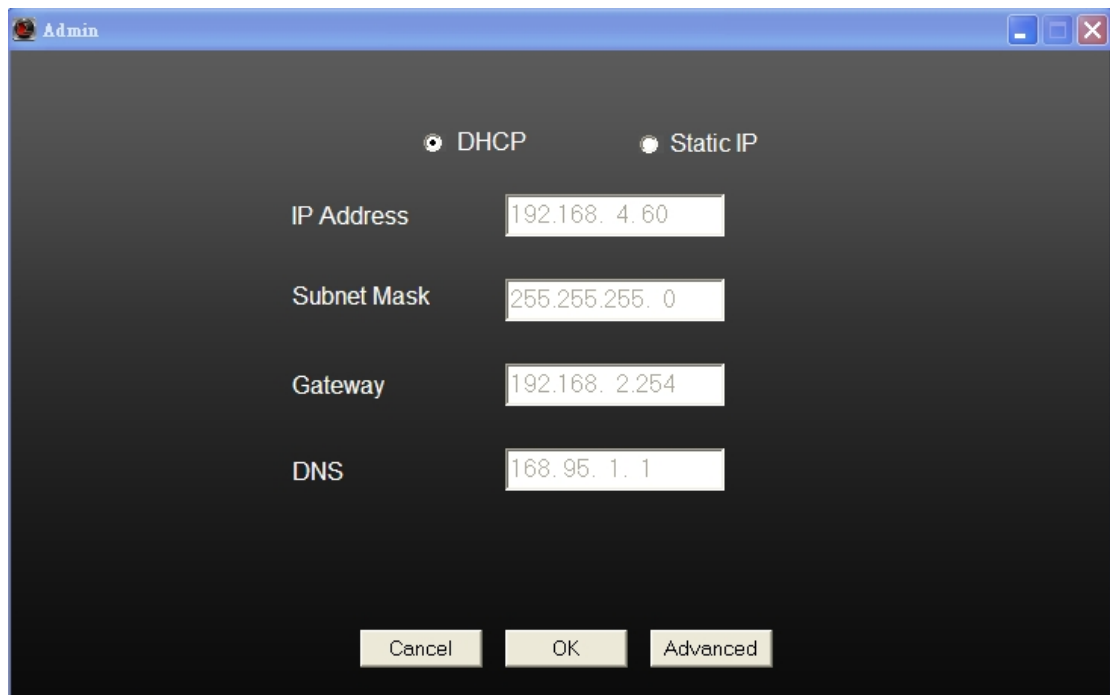

The screenshot shows a window titled 'Admin' with a dark background. At the top, there are two radio buttons: 'DHCP' (which is selected) and 'Static IP'. Below these are four input fields with labels to their left: 'IP Address' (192.168. 4. 60), 'Subnet Mask' (255.255.255. 0), 'Gateway' (192.168. 2.254), and 'DNS' (168.95. 1. 1). At the bottom of the window, there are three buttons: 'Cancel', 'OK', and 'Advanced'.

In 'Lan Setting' page, you can configure camera's network settings. Select 'DHCP' to set the camera to obtain an IP address from DHCP server on local area network automatically, and select 'Manual IP' to input the IP address information manually. Click 'OK' to save settings.

1.9 Logging in the Management Interface

Make sure the network camera is correctly powered (Power LED is on), and then launch Internet Explorer and type the IP address of the network camera in address bar of Internet Explorer. You should be prompted to input the user name and password:



Default user name is 'admin' and password is '1234'. Click 'OK' to continue after user name and password has entered.

If you're rejected, maybe the password has been modified previously. This should not happen if this is a newly-purchased camera, however, if you get the camera from someone else, the password would be changed. Please try to obtain the correct user name / password, or you'll have to reset the camera.

If this is the first time you log onto web management interface, you'll be prompted to install ActiveX Plugin:

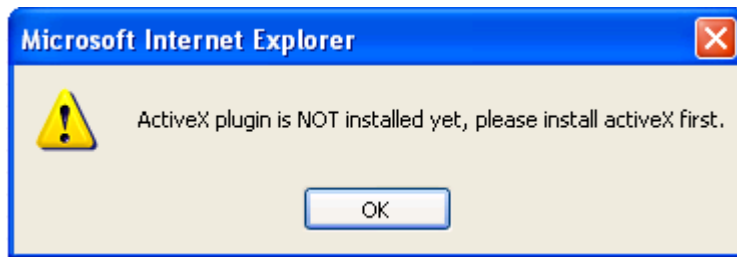

When you see this message, please click 'OK', and click 'Download the latest ActiveX' link to download plugin so you can use this camera:

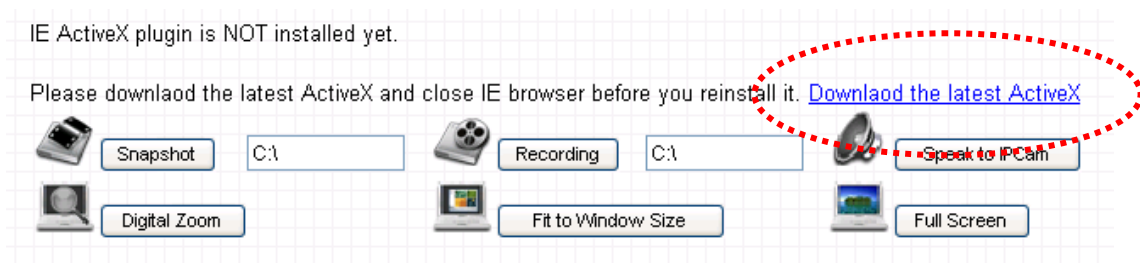

Click 'Run' to download plugin:

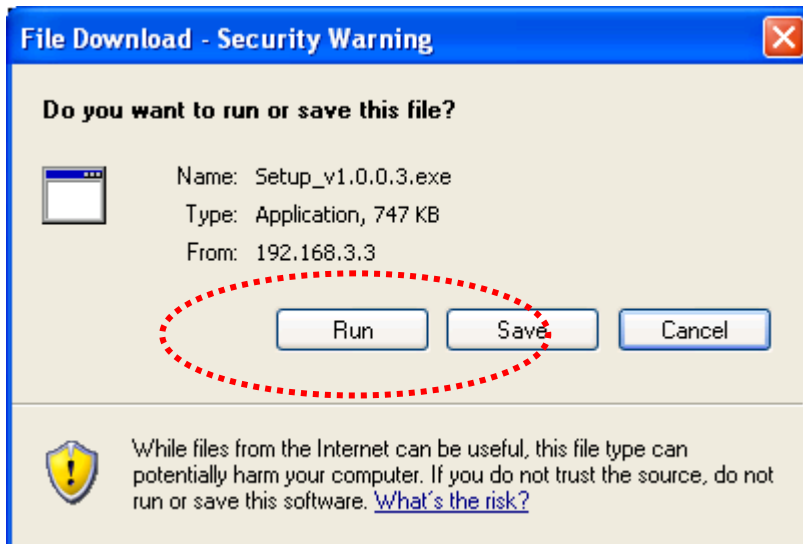

Click 'Run' to install plugin:



Please click 'Next' button to start installation (click 'Next' or 'Install' when you're prompted, until installation is complete).

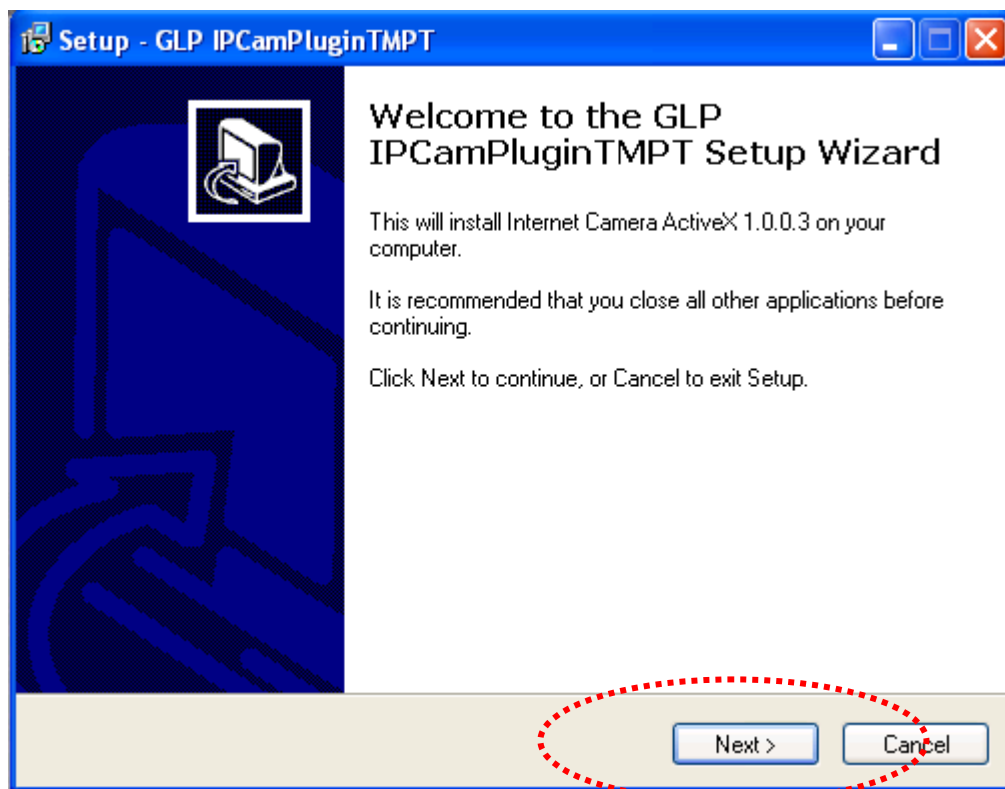

Click 'Finish' to complete plugin installation.

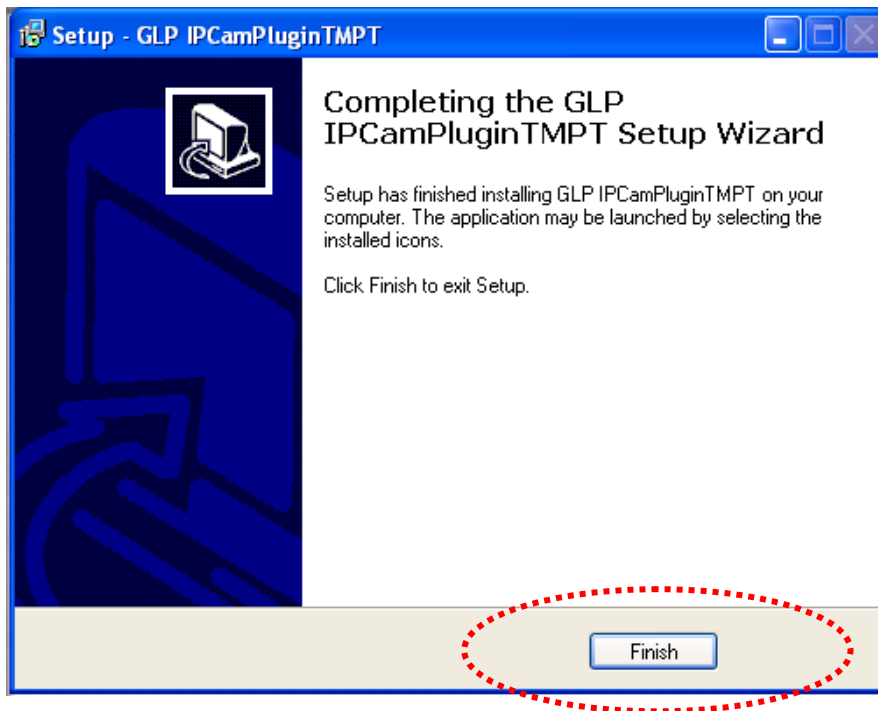

Now you can go back to web browser, and you should be able to see the image captured by camera (You may need to press F5 or CTRL-R to reload web page).

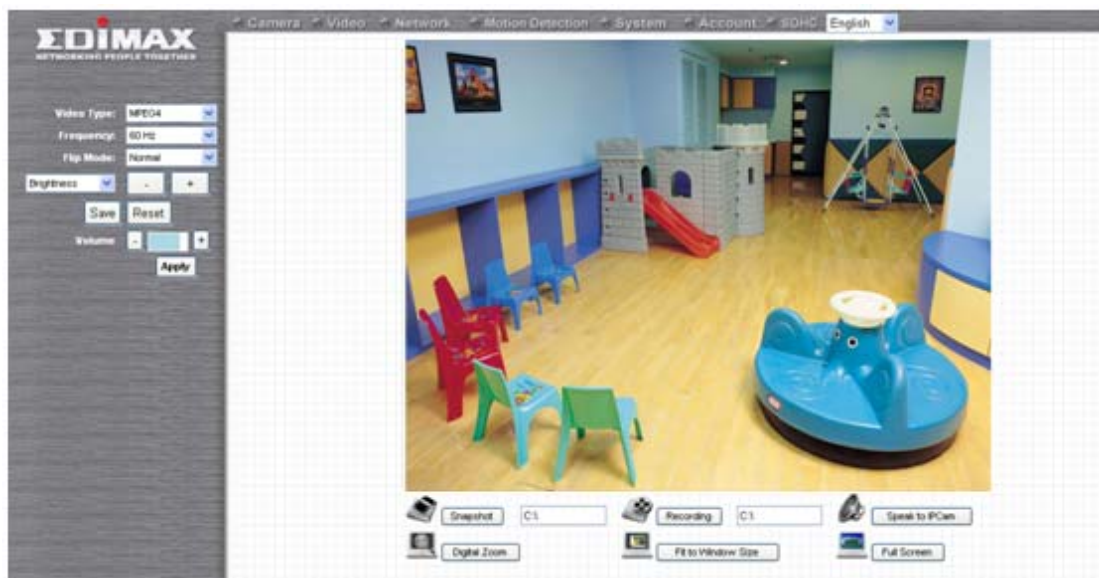

Note: If you see one of these messages (or both):

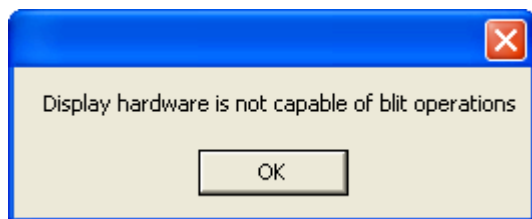

OR

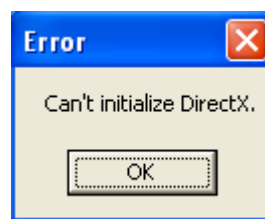

Your computer may not have the display capability that this Network Camera requires, or you don't have Microsoft DirectX® installed. Please download Microsoft DirectX® from Microsoft's website (<http://www.microsoft.com>), and try again.

In some cases, your computer is able to display the image from Network Camera correctly, but you'll still see these messages. If this happens, just ignore them.

Chapter II: Using Web Management Interface

2.1 Camera Settings

The first menu after you logged onto web management interface is 'Camera', and this is the only menu you can see the real-time image from camera.

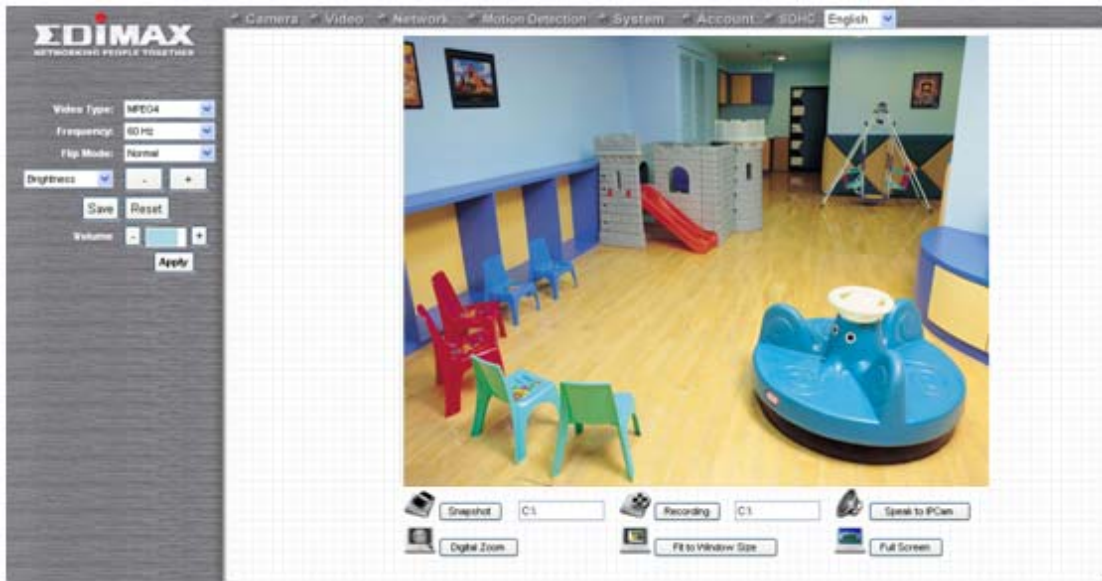



You can always back to this menu by clicking 'Camera' on the top of web management interface.

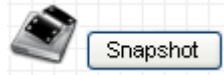

The descriptions of every setting in this menu will be given below:

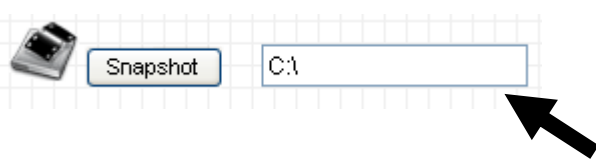
Item	Description
Video Type	Specifies video encoding type. Available options are 'MPEG4', 'MJPEG', and 'H.264'. Different encoding type requires different bandwidth, and provides different video quality.
Frequency	If the place where this Network Camera points to has a (or more) fluorescent light(s), the image may look flashing. In this case, you can adjust this setting to the frequency of electrical power; this can improve the image quality effectively. If you don't know which one you should use, just try any of them and select one with less flicker.
Flip Mode	If you're not putting this camera on a horizontal surface but hang the camera on the ceiling or wall, you can use this function to rotate the displaying image.
Brightness / Saturation / Sharpness	Select brightness, saturation, and sharpness from dropdown menu, and click ' - ' or ' + ' button to increase or decrease brightness / saturation / sharpness setting value. In certain environment, adjust brightness, saturation, and / or sharpness will help improve video quality.
Volume	Adjust the volume of audio output. Press ' + ' or ' - ' button to increase or decrease volume.
<p><i>NOTE: When you change any setting(s) listed above, please click 'Apply' button so the change(s) will take effect. For following functions, changes will take effect right away.</i></p>	
<p>Snapshot</p> 	<p>Click 'Snapshot' button to save the displaying image as an image file, a message box will appear after you click 'Snapshot' button, showing the filename and location of saved image file (default filename is current date and time).</p> <p>Default directory used to save image file is 'C:\', you</p>

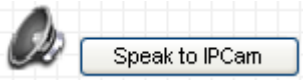
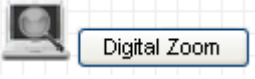
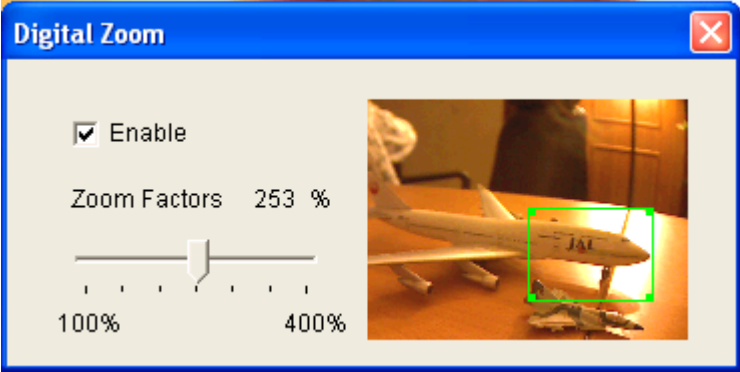
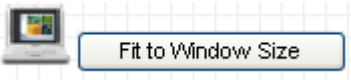
	<p>can change the directory by clicking the text input box located at the right of 'Snapshot' button:</p>  <p>and you'll be prompted to select a new directory.</p>
<p>Recording</p> 	<p>Press this button to record the displaying image as a video file in AVI format, and you can play the video file back by Windows Media Player. To stop recording, press 'Stop Recording' button (the same button). You can also change the directory used to save video file.</p>
<p>Speak to Network Cam</p> 	<p>You can transmit the voice received by your computer's microphone to the camera's external speaker. Press and hold this button, then speak to the microphone. Please note that external speaker must be connected to this camera.</p>
<p>Digital Zoom</p> 	<p>If you wish to enlarge certain portion of the captured image, you can click this button to set digital zoom:</p>  <p>Click 'Enable' to enable digital zoom function, then you can drag the slide bar to adjust zoom ratio. You can also use your mouse to drag the zoom area (the green square) to reposition the zoom area.</p>
<p>Fit to Window Size</p> 	<p>Click this button and the image size will be adjusted to fit the size of browser window.</p>
<p>Full Screen</p>	<p>Click this button to display the image in full-screen</p>

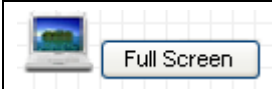

mode (uses all available space to display the image captured by this camera).

*Please note: If you're not using Microsoft Internet Explorer as web browser, some functionalities may not work properly.

2.2 Video

You can change video-related settings of this Network Camera in 'Video' menu. You can access this menu by clicking 'Video' on the top of web management interface.



There are 5 types of video settings for this Network Camera. To set the option of a certain video setting, put mouse cursor on it and its options will appear.



2.1.1 MJPEG

You can adjust video settings when you select 'MJPEG' as video type in 'Camera' menu.

MJPEG

✔ Video Resolution : ▼

✔ Video Quality : ▼

✔ Frame Rate : ▼

The descriptions of every setting in this menu will be given below:

Item	Description
Video Resolution	Changes the resolution of video. Available options are 1280 x 1024, 640 x 480, and 320 x 240. Higher resolution provides better video quality and more detail, but requires more network bandwidth.
Video Quality	Changes video quality. There are 5 levels of video quality from 'Lowest' to 'Highest'. Selecting a higher video quality will provide better video quality, but requires more network bandwidth.
Frame Rate	Changes video frame rate. Available options from '30' to '1', indicates how many video frames this camera will transmit every second. Higher frame rate provides smooth video watching experience and will not lose details of video, but requires more network bandwidth. If you're using this video camera with insufficient network bandwidth, selecting a lower frame rate setting will help.

Click 'Apply' for settings to take effect.

2.1.2 MPEG4

You can adjust video settings when you select 'MPEG4' as video type in 'Camera' menu.

MPEG4

✔ Video Resolution : ▼

✔ Video Quality : ▼

✔ Frame Rate : ▼

The descriptions of every setting in this menu will be given below:

Item	Description
Video Resolution	Changes the resolution of video. Available options are 1024 x 768, 640 x 480, and 320 x 240. Higher resolution provides better video quality and more detail, but requires more network bandwidth.
Video Quality	Changes video quality. There are 5 levels of video quality from 'Lowest' to 'Highest'. Selecting a higher video quality will provide better video quality, but requires more network bandwidth.
Frame Rate	Changes video frame rate. Available options from '30' to '1', indicates how many video frames this camera will transmit every second. Higher frame rate provides smooth video watching experience and will not lose details of video, but requires more network bandwidth. If you're using this video camera with insufficient network bandwidth, selecting a lower frame rate setting will help.

Click 'Apply' for settings to take effect.

2.1.3 H.264

You can adjust video settings when you select 'H.264' as video type in 'Camera' menu.

H.264

✔ Video Resolution :

✔ Video Quality :

✔ Frame Rate :

The descriptions of every setting in this menu will be given below:

Item	Description
Video Resolution	Changes the resolution of video. Available options are 1280 x 1024, 640 x 480, and 320 x 240. Higher resolution provides better video quality and more detail, but requires more network bandwidth.
Video Quality	Changes video quality. There are 5 levels of video quality from 'Lowest' to 'Highest'. Selecting a higher video quality will provide better video quality, but requires more network bandwidth.
Frame Rate	Changes video frame rate. Available options from '30' to '1', indicates how many video frames this camera will transmit every second. Higher frame rate provides smooth video watching experience and will not lose details of video, but requires more network bandwidth. If you're using this video camera with insufficient network bandwidth, selecting a lower frame rate setting will help.

Click 'Apply' for settings to take effect.

2.1.4 OSD

If you need to display information about this camera, like camera's name or current date / time, you can use OSD (On-Screen Display) menu:

On-Screen Display

✔ On-Screen Display : Enable Disable

✔ Show Camera Name : Enable Disable

✔ Show Date : Enable Disable

✔ Show Time : Enable Disable

The descriptions of every setting in this menu will be given below:

Item	Description
On-Screen Display	Select 'Enable' to enable on-screen display function (information about this camera will be displayed on camera's display image), and select 'Disable' to disable it.
Show Camera Name	Select 'Enable' to show camera's name on camera's display image, select 'Disable' to hide it.
Show Date	Select 'Enable' to show current date on camera's display image, select 'Disable' to hide it.
Show Time	Select 'Enable' to show current time on camera's display image, select 'Disable' to hide it.

Click 'Apply' for settings to take effect.

When OSD is enabled, selected OSD items will be displayed like this:

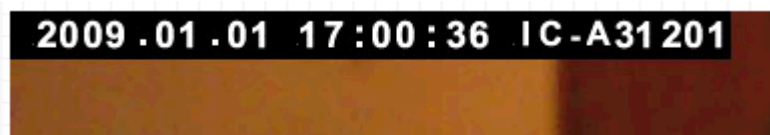

2.2 Network Settings

All network-related settings can be found in this menu, and you have to specify TCP/IP parameters in this menu if you want to change IP address, use PPPoE, Dynamic DNS, and activate UPnP function.

You can access this menu by clicking 'LAN' on the top of web management interface.



After you selected 'Network', network setting menu will appear. There are 6 sub-menus available here:

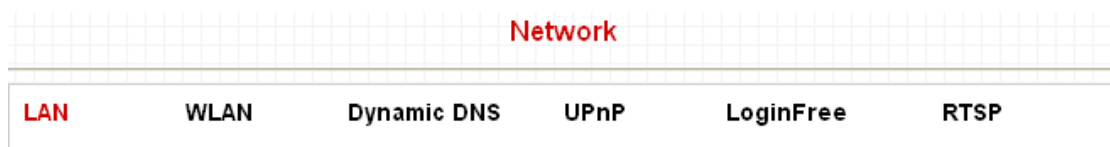

Please click the network setting you wish to set, and then refer to instructions given below:

2.2.1 LAN

You can define IP address and select the port number you wish to use here.

LAN

- ✔ Network Type : DHCP Static IP Address
- ✔ IP Address :
- ✔ Subnet Mask :
- ✔ Gateway :
- ✔ Primary DNS :
- ✔ Secondary DNS :
- ✔ Web Port :

PPPoE

- ✔ Enable PPPoE : Enable Disable
 - ✔ User Name :
 - ✔ Password :
 - ✔ MTU : (512<=MTU Value<=1492)
-

The descriptions of every setting in this menu will be given below:

Item	Description
Network Type	<p>This camera can obtain the IP address from DHCP server automatically (if you have one), or set a fixed IP address. Select 'DHCP' to obtain IP address automatically or 'Static IP Address' to assign this Network Camera with a fixed IP address.</p> <p>When 'DHCP' is selected, IP address parameters below will be grayed out.</p>
IP Address	Specify the IP address for this Network Camera here.
Subnet Mask	Specify the subnet mask for this Network Camera here.
Gateway	Specify the gateway address of the local network here.
Primary DNS	Specify the IP address of DNS server here. Please input IP address only. If you don't know the address of DNS server, ask network administrator or your ISP for help.
Secondary DNS	<p>Specify the IP address of backup DNS server here. When primary DNS is unreachable, Network Camera will use the IP address specified here as DNS server.</p> <p>This field is optional.</p>
Web Port	<p>Specify the port number of web management interface here. If it's not 80, you'll have to add ':port' after the IP address / hostname of this Network Camera.</p> <p>For example, if the HTTP port number you specified here is 90 and the IP address of Network Camera is 10.20.20.30, then you have to input 'http://10.20.20.30:90' in the address bar of Internet explorer.</p>
Enable PPPoE	Select 'Enable' to activate PPPoE function of this Network Camera, select 'Disable' to disable it.
User Name	Input the PPPoE username assigned by your ISP here.
Password	Input the PPPoE password assigned by your ISP here.
MTU	Input the MTU (Maximum Transmission Unit) given by your ISP here. Ask your ISP if you don't know what value you should input here. Default value should work with

	most of ISPs and will give you a nice network performance.
--	------------------------------------------------------------

Click 'Apply' to save settings and make the new settings take effect.

2.2.2 WLAN

Wireless LAN

Wireless Connection : Enable Disable

Network Type : Infrastructure

Available Networks :

Connect	SSID	MAC Address	Signal	Channel	Encryption	Network Type
<input checked="" type="radio"/>		00:07:40:FE:60:7E		4	WPAPSK(TKIP)	Infrastructure
<input type="radio"/>	books	00:1B:11:62:84:68		8	WPA2PSK(AES)	Infrastructure

SSID :

Channel :

Wireless Key :

WPS

Self PinCode : 31500203

Configure via Push Button :

Configure via PinCode : Registrar SSID :

The descriptions of every setting in this menu will be given below:

Item	Description
Wireless Connection	Select 'Enable' to activate wireless network function of this Network Camera, select 'Disable' to disable it.
Network Type	Select the network type of wireless connection. Available options are 'Infrastructure' (Connect the Network Camera to a wireless access point), and 'Adhoc' (This Network Camera will become a stand-alone wireless network point, other wireless computers / devices can discover this Network Camera and connect

	<p>to it without wireless access point).</p> <p>You can set to 'Adhoc' when you don't have any wireless access point, but your computer has wireless network card. Set to 'Infrastructure' when you have wireless access point, and you have computers with wired network connection.</p>
<p>Available Networks</p>	<p>Here shows all wireless access points found by this Network Camera. Please note not all access points will be displayed at the same time, if the access point you expected to connect does not appear, you may have to click 'Refresh' button for several times until it appears.</p> <p>The descriptions of all fields is listed below:</p> <p>Connect: You can select the wireless access point you wish to connect here.</p> <p>SSID: the SSID of all found wireless access points will be shown here. Some wireless access point may hide their SSID; in this case, you have to identify them by their MAC address.</p> <p>MAC Address: If you there are many wireless access points in proximity or some wireless access point hides it's SSID, you can use MAC address to distinguish them.</p> <p>Signal: Shows the radio signal strength in percent.</p> <p>Channel: Shows the radio channel of this wireless access point.</p> <p>Encryption: Shows the encryption type used by this wireless access point. You must use the same encryption type if you wish to connect to a certain wireless access point. If the wireless access point does not use encryption, 'Disabled' will be displayed here.</p> <p>Network Type: Shows the network type of a certain wireless access point (Infrastructure or Adhoc).</p>

SSID	<p>Input the SSID of the wireless access point you wish to connect. It should be less than 32 alphanumerical characters.</p> <p>When you select a wireless access point above, it's SSID will be filled in this field automatically. However, if the SSID is not displayed (the wireless access point you selected choose to hide it's SSID), you have to know it's SSID and input it here, or you will not be able to connect it.</p>
Channel	<p>Select the radio channel you wish to use here. When network type is 'Infrastructure', the radio channel is auto-selected according to the channel that wireless access point uses. You can only select the channel number when network type is 'Adhoc'.</p>
Wireless Key	<p>Input the encryption key of selected wireless access point here. This is required when access point you wish to connect uses encryption.</p>
Self PinCode	<p>Here displays the WPS pin code used to connect to WPS-enabled wireless access points. You have to input this number into the WPS enabled access point to establish WPS connection.</p>
Configure via Push Button	<p>Click this button and this camera will enter PBC-style WPS connection state for 120 seconds. Please push 'Start PBC' button on the wireless access point you wish to connect within 120 seconds to establish WPS connection (The remaining time will be displayed on the button).</p> <p>If connection can not be established after 120 seconds, you'll be prompted by a message box, and you can press 'Start PBC' button to try again.</p>
Configure via PinCode	<p>If you have wireless access point's WPS PIN code, you can input it here and press 'Start PIN' button to start to establish PIN-style WPS connection.</p>

2.2.3 Dynamic DNS

If your ISP does not give you a fixed Internet IP address (i.e. the Internet address you're using when you access the Internet is not always the same – ask your ISP for detailed information), you can use this function to help you locate the IP address of this Network Camera when you're away from home or office.

Before you can use this function, you'll need to apply for an account at dyndns.org/ no-ip.com (<http://www.dyndns.org/> or <http://www.no-ip.com>). Detailed instructions of how to apply a new account can be found on dyndns.org's or no-ip.com website.



Dynamic DNS

✔ Enable DDNS : Enable Disable

✔ Provider :

✔ Host Name :

✔ User Name :

✔ Password :

The descriptions of every setting in this menu will be given below:

Item	Description
Enable DDNS	Select 'Enable' to activate Dynamic DNS function of this Network Camera, select 'Disable' to disable it.
Provider	Select dynamic DNS service provider here. Dyndns.org or no-ip.com is available currently.
Host Name	Input dynamic DNS host name here.
User Name	Input dynamic DNS user name here, must be the same as the one you applied on dyndns.org or no-ip.com.
Password	Input dynamic DNS password here, must be the same as the one you applied on dyndns.org or no-ip.com.

Click 'Apply' to save settings and make the new settings take effect.

2.2.4 UPnP

When UPnP function is activated, all UPnP-compatible computers / network devices will be able to discover this Network Camera automatically (only those in the same local network).

This function is useful and you don't have to remember the IP address of this Network Camera. Simply open 'Network neighbor' and it's there!



The descriptions of every setting in this menu will be given below:

Item	Description
Enable UPnP	Select 'Enable' to activate UPnP function of this Network Camera, select 'Disable' to disable it.

Click 'Apply' to save settings and make the new settings take effect.

After UPnP function is activated, a popup message will appear:

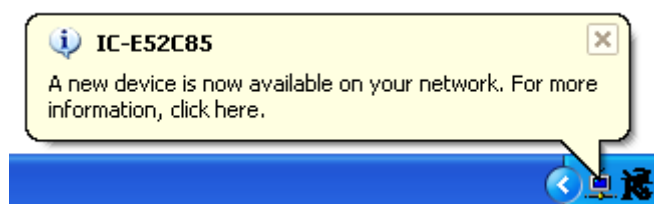

Click the message to open 'My Network Places', and you'll see the Network Camera:

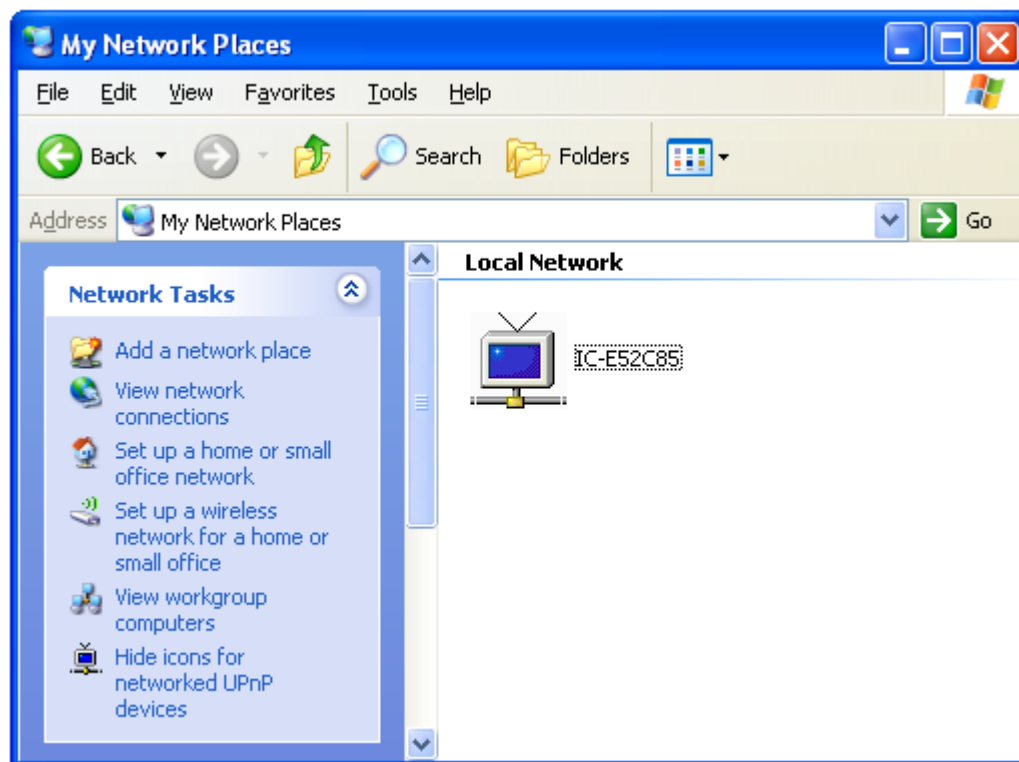

You can double-click the icon to launch Internet Explorer and log onto Network Camera's web management interface directly.

2.2.5 LoginFree

This camera provides a method to let unauthorized users to view the image captured by this camera, which is called as 'LoginFree'. When you wish to let everyone to view the image captured by this camera, or integrate the image with your own web application, you can use this function:

LoginFree

✔ Filename : .jpg

Input the filename here, and click 'Apply' to save settings, then other users can access the image by this filename with .jpg extension with the camera's IP address as prefix. For example, if your camera's IP address is '192.168.2.1' and the filename you set here is 'picture', then everyone on the web can access the image captured by this camera by using the following address:

<http://192.168.2.1/picture.jpg>

Please note that no authentication will be required to see the captured image. If you wish to disable this function, clear the text in 'Filename' field and click 'Apply'.

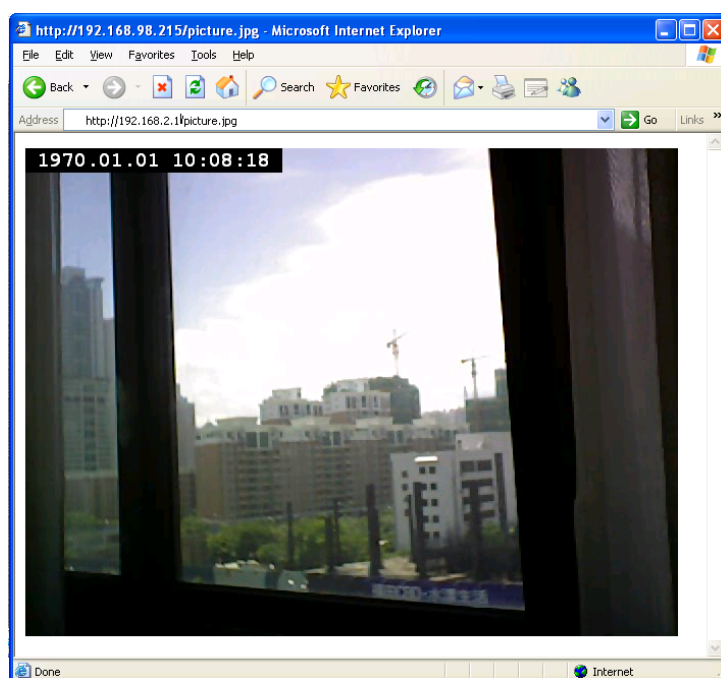

2.2.6 RTSP

If you want to watch video captured by this Network Camera by your own RTSP (Real Time Streaming Protocol) media player, you can use this function to setup RTSP parameters, so your RTSP-compatible player will be able to receive video data.

Video Streaming

✔ RTSP Port :

✔ MPEG4 RTSP Path : .sdp

✔ H264 RTSP Path : .sdp

✔ RTP Port Range : -

The descriptions of every setting in this menu will be given below:

Item	Description
RTSP Port	Input the port number of RTSP here. Default setting is 554.
MPEG4 RTSP Path	Input the path of MPEG4 RTSP video file. When you use RTSP-compatible media player to play RTSP stream, please remember to add '.sdp' file extension.
H.264 RTSP Path	Input the path of H.264 RTSP video file. When you use RTSP-compatible media player to play RTSP stream, please remember to add '.sdp' file extension.

2.3 Motion Detection

When you wish to use this camera to monitor the activities, motion detection function will be very useful. Camera will detect the motion in captured image, and take a snapshot when motion is detected. So you can use this camera to keep the safety of the belongings you have.

To use motion detection, click the following link from the top of menu:



After you selected 'Motion Detection', a sub-menu will appear. There are 5 sub-menus available here:



Detailed descriptions of every setting will be given below.

2.3.1 Motion Detection

You can use this menu to setup basic motion detection settings:

Motion Detection

- ✔ Enable Motion Detection : Enable Disable
- ✔ Motion Detection Interval : 5 seconds
- ✔ Recording Time : 3
- ✔ Sending File Type : JPEG
- ✔ Send snapshot file to FTP : Enable Disable
- ✔ Send snapshot file to E-Mail : Enable Disable

SD Card

- ✔ SD Card Record : Enable Disable
- ✔ Storage File Type : JPEG
- ✔ Record File Size : 10 MBytes (Max 100 MB)

Samba Network

- ✔ Record to Folder : Enable Disable
 - ✔ Authentication : Anonymous
 - ✔ User Name :
 - ✔ Password :
 - ✔ Samba Server : 192.168.3.61
 - ✔ Shared Folder : share
 - ✔ Storage File Type : JPEG
 - ✔ Record File Size : 10 MBytes (Max 100 MB)
-

The descriptions of every setting in this menu will be given below:

Item	Description
Enable Motion Detection	Select 'Enable' to enable motion detection, and select 'Disable' to disable this function.
Motion Detection Interval	Select the time interval between two motions from dropdown menu. When a motion is detected, camera will not detect any motion again within the time interval you specified here. Available options are from 0 second (always detect new motion) to 60 seconds.

Recording Time	Select the duration you wish this camera to record image when a motion is detected from dropdown menu. Available options are 1, 2, 3, 4, and 5 (seconds).
Sending File Type	Select the file type that will be saved when a motion is detected. Select 'JPEG' and a still picture in JPEG format will be saved; and select 'AVI' to save a motion video clip.
Send snapshot file to FTP	Select 'Enable' to send the saved file to appointed FTP server when a motion is detected, select 'Disable' to disable this function. You have to configure FTP server parameters in 'FTP Configuration' menu first, so this function will take effect (see below).
Send snapshot file to E-Mail	Select 'Enable' to send the saved file to appointed E-mail address when a motion is detected, select 'Disable' to disable this function. You have to configure mail server parameters in 'FTP Configuration' menu first, so this function will take effect (see below).
SD Card Record	Select 'Enable' to record detected motion to SD card (if there's one), and select 'Disable' to disable this function.
Storage File Type	Select saving file type for motion detection: JPEG (still picture) or AVI MPEG4 / AVI H264 (for motion picture).
Record File Size	Input the maximum file size of saved file in Mbytes. Maximum file size is 100.
Record to Folder	Select 'Enable' to save file to a network folder which supports SAMBA (also known as 'Windows Network Neighborhood'), select 'Disable' to disable this function.
Authentication	If username and password are not required to write files in specified folder, select 'Anonymous'; if required, select 'Account'.
User Name	Input user name required by destination network folder.
Password	Input password of the user name required by destination network folder.
Samba Server	Input the IP address or host name of network file server.
Shared Folder	Input the folder name on file server.
Storage File Type	Select saving file type for motion detection: JPEG (still picture) or AVI MPEG4 / AVI H264 (for motion picture).
Record File Size	Input the maximum file size of saved file in Mbytes. Maximum file size is 100.

Click 'Apply' to save settings and make the new settings take effect.

2.3.2 Motion Region

You can define the motion detection region within the image that camera captures, so this camera will ignore motions which are not covered by the motion region setting, and reduce the chances of false alarm.



The descriptions of every setting in this menu will be given below:

Item	Description
Region 1 – 3	Check the box to enable motion detection region 1 to 3. You can check multiple boxes to enable multiple motion detection regions. When you checked a box, a new region (and region number) will be displayed on captured image.

Sensitivity	Move the slide bar to change the motion detection sensitivity setting: Drag the slide to the right to increase sensitivity (camera will detect minor changes in the image), and drag the slide to the left to decrease sensitivity (camera will only detect major changes in the image).
Refresh	In case the objects of the image captured by the camera moved, click this button to reload the image captured by camera, so you can decide the motion detection region more precisely.
Save	Save motion detection region settings.

To change the motion detection region, you can 'resize' and 'reposition' it:



Move the mouse cursor to the eight dots located at the border of motion detection region, and the mouse cursor will switch to \leftrightarrow , \nwarrow , or \updownarrow . You can click and hold mouse button and move the mouse to resize the motion detection region.

To move reposition the motion detection region, move the mouse within the motion detection region, and the mouse cursor will switch to $\left\langle \oplus \right\rangle$. Click and hold mouse button and move the mouse to reposition the motion detection region.

2.3.3 Email

You can define the destination address of E-mail sending and mail server parameters here.

E-Mail

✔ Recipient E-Mail Address :
 ✔ E-Mail Subject :
 ✔ SMTP Server :
 ✔ Sender E-Mail Address :
 ✔ SMTP Port :
 ✔ SMTP enable SSLv2/v3 function : Enable Disable
 ✔ SMTP Authentication : Enable Disable
 ✔ User Name :
 ✔ Password :

The descriptions of every setting in this menu will be given below:

Item	Description
Recipient E-Mail Address	Input the email recipient's Email address here.
E-Mail Subject	Specify the title of sending email, so you can identify the mail sent from this camera from others quickly.
SMTP Server	<p>Input the IP address or host name of the SMTP server (the server that delivers the Email for you) here.</p> <p>If you don't know, please refer to the SMTP server you're using in your Email software (like Outlook, Outlook Express etc.), or ask your network administrator or ISP.</p>
Sender E-Mail Address	<p>Input the Email address of mail sender, this will help you to identify the Email sent by this Network Camera by sender's Email address.</p> <p><i>NOTE: Some mail server would reject to deliver the Email from unknown sender, it's recommended to input your own Email address here, or any other actual one.</i></p>
SMTP Authentication	Some SMTP server requires mail senders to be authenticated before they can send Email. If your SMTP

	server requires you to do so, please select 'Enable', or select 'Disable' to disable it. If you don't know, please refer to the SMTP server you're using in your Email software (like Outlook, Outlook Express etc.), or ask your network administrator or ISP.
User Name	Please input the user name of SMTP server here, if your SMTP server requires the use of authentication.
Password	Please input the password of SMTP server here, if your SMTP server requires the use of authentication.

Click 'Apply' to save settings and make the new settings take effect.

After that, you can click 'Send a test email' to send a testing Email to the address you set here, so you can make sure the setting you specified here is correct and working.

2.3.4 FTP Configuration

You can set FTP server's parameters here.

FTP Configuration

✔ FTP Server :

✔ FTP Port :

✔ User Name :

✔ Password :

✔ Remote Folder :

✔ Passive Mode : Enable Disable

The descriptions of every setting in this menu will be given below:

Item	Description
FTP Server	Input the IP address or host name of the FTP server you wish to use here.
FTP Port	Input the port number of the FTP server you wish to use here.
User Name	Input the user name of the FTP server you wish to use here.
Password	Input the password of the FTP server you wish to use here.
Remote Folder	<p>Input the remote folder name on the FTP server here. If nothing is specified here, all uploaded image files will be placed in FTP server's root directory.</p> <p>Please ask FTP server's administrator to know which folder you should use. Certain user name may have restrictions and therefore can not place the file in the directory not owned by the user.</p>
Passive Mode	<p>Select 'Enable' to use passive mode to send file, or select 'Disable' to not to use passive mode to send file.</p> <p>Some FTP servers require passive mode, if you don't know, please ask FTP server's administrator; most of FTP servers will work fine with both modes, but if you</p>

	found that non-passive mode is not working, you can try to use passive mode.
--	------------------------------------------------------------------------------

Click 'Apply' to save settings and make the new settings take effect.

After that, you can click 'Upload a test file' to send a file to the FTP server you set here, so you can make sure the setting you specified here is correct and working.

2.3.5 SD Card Configuration

You can define the filename and destination folder when saving a file in SD card.

SD Card Configuration

Enable Cycle Recording

♥ File Name Prefix :

♥ Destination Folder :

The descriptions of every setting in this menu will be given below:

Item	Description
Enable Cycle Recording	Check this box and this camera will automatically erase oldest image file to make rooms for new image files when SD card is full. If you don't want to lose old image files, do not check this box.
File Name Prefix	Specify the filename prefix (the texts which will be added before the file sequence number).
Destination Folder	Specify the folder name that camera will store the saved image or video clip.

Click 'Apply' to save settings and make the new settings take effect.

2.4 System Info

You can use this menu to get the operational information of this camera:



After you selected 'System Info.', a sub-menu will appear. There are 4 sub-menus available here:

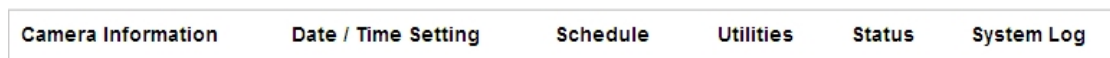

Detailed descriptions of every setting will be given below.

2.4.1 Camera Information

Camera information allows you to set the name and administrator's password of this camera.

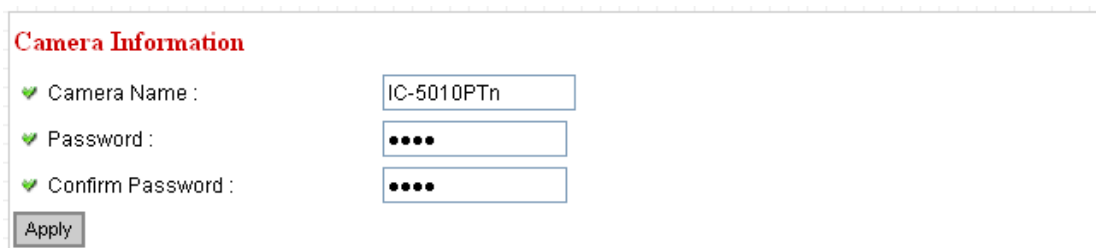

Camera Information

✔ Camera Name :

✔ Password :

✔ Confirm Password :

The descriptions of every setting in this menu will be given below:

Item	Description
Camera Name	<p>Please specify the name of this Network Camera here. This can be used to identify your camera on the network when you have more than one Network Camera in the same network.</p> <p>Default name begins with 'IC-' plus the last 6 characters of the MAC address of this Network Camera. You can modify the name to the one you can remember and meaningful to you, but never give all Network Cameras in the same network with same name.</p>
Password	<p>Please specify user name 'admin' 's password here. (The one you need when you log onto web management interface and use 'admin' as user name.</p>
Confirm Password	<p>Please input the same password again, to make sure there's no typo.</p>

Click 'Apply' to save settings and make the new settings take effect.

2.4.2 Date / Time Setting

This setting allows you to change the date and time of the real time clock in this Network Camera. You can set the time manually, or use network time protocol (NTP) to set the time automatically.

Date / Time Setting

Set Date/Time manually / / : :

NTP Server

Time Zone : (GMT+08:00) Taipei

NTP Server : pool.ntp.org

Daylight Saving Time : Yes No

The descriptions of every setting in this menu will be given below:

Item	Description
Set Date/Time manually / NTP Server	<p>If you select 'Set Date/Time manually', you can set the date and time of this camera manually. Please input the date and time you wish to set here.</p> <p>Date / time format is YYYY / MM / DD HH:MM:SS Time is in 24-hour format.</p> <p>You can click 'Synchronize to PC time' to use the time of the computer you're using.</p> <p><i>Example: 24th August 2007 = 2007/ 08 / 24, and PM 9:24:30 = 21:24:30</i></p> <p>If you select 'NTP Server', the camera will get the date and time from NTP Server automatically.</p>
Time Zone	Please select the time zone of the country / city of resident from dropdown menu here.
NTP Server	Please input the IP address or host name of NTP server here. You can use default value 'pool.ntp.org', or ask your ISP for the IP address or host name, if they have one.
Daylight Saving	If your area of residence uses daylight saving, select

Time	'Yes'; otherwise select 'No'.
Synchronize to PC time	Click to input current time of your computer to 'Set Date / Time manually' field.

Click 'Apply' to save settings and make the new settings take effect.

If you wish to use the date and time setting of the computer which is connecting to the camera, click 'Synchronize to PC time' button. The date and time setting of the computer will be filled to date and time setting in this page.

2.4.3 Schedule

You can use this menu to setup Schedule Snapshot/Recording settings:

Schedule Snapshot

Enable FTP Schedule : Enable Disable
 Time Interval : Upload one image to FTP server every hour(s) /Frame
 Upload one image to FTP server every Frames per Second
 File Control : Upload files with filename composed of date / time
 Overwrite file with the same filename : .jpg

Enable E-Mail Schedule : Enable Disable
 Time Interval : Send one image every hour(s)

Schedule Recording

Enable Schedule Recording : Enable Disable
 Time Interval : Send one recording file every minute(s)
 Recording Time : seconds (from 1 second to 10 seconds)

Send Recording File to FTP : Enable Disable
 File Control : Upload files with filename composed of date / time
 Overwrite file with the same filename : .avi

Send Recording File to E-Mail : Enable Disable

Item	Description
Enable FTP Schedule	Select 'Enable' to send the Schedule Snapshot to the appointed FTP server, or select 'Disable' to disable this function. You have to configure FTP server parameters in 'FTP Configuration' menu first, so this function will take effect.

Time Interval	You can choose to upload one image to FTP server according to the time interval you wish, or choose to upload image as you wish to FTP server every second.
File Control	This option allows you to choose to upload each schedule snapshot with different file name composed of date/time, or to choose to upload the schedule snapshot with the same file name you wish. If you choose the latter, the prior-saved schedule snapshot will be overwritten by the latest schedule snapshot.
Enable E-Mail Schedule	Select 'Enable' to send the Schedule Snapshot to the appointed e-mail address, or select 'Disable' to disable this function. You have to configure e-mail settings in 'Email' menu first, so this function will take effect.
Time Interval	This option allows the network camera to send one image according to the time interval you wish.
Enable Schedule Recording	Select 'Enable' to enable schedule recording, or select 'Disable' to disable this function.
Time Interval	This option allows the network camera to send one recording file according to the time interval you wish.
Recording Time	This option allows you to adjust the recoding time based on your preference. Note: <i>The available recording time is based on the video resolution and video frame rate settings in 'Video' menu.</i>
Send Recording File to FTP	Select 'Enable' to send the recoded video to the appointed FTP server, or select 'Disable' to disable this function. You have to configure FTP server parameters in 'email & FTP' menu first, so this function will take effect.
File Control	This option allows you to choose to upload each recorded video with different file name composed of date/time, or to choose to upload the recorded video with the same file name you wish. If you choose the latter, the prior-saved recorded video will be overwritten by the latest recorded video.
Send Recording File to E-Mail	Select 'Enable' to send the recorded video to the appointed e-mail address, or select 'Disable' to disable this function. You have to configure e-mail settings in 'email & FTP' menu first, so this function will take effect.

2.4.4 Utilities

This menu allows you to upgrade firmware, clear all settings, reboot the Network Camera, and switch LED lights on/off.

Utilities

✔ Upgrade Firmware :

✔ Reset To Factory Defaults :

✔ Reboot Device :

✔ LED Setting :

The descriptions of every setting in this menu will be given below:

Item	Description
Upgrade Firmware	<p>If you downloaded latest firmware file from our website, you can click 'Browse' button to pick a firmware file located on your computer's hard drive and you can upload the firmware file to the Network Camera later.</p> <p>After you selected a proper firmware file from your computer, click 'Upgrade Firmware' button to start upgrade. DO NOT DISCONNECT NOW!</p> <p>If the firmware file you provided is invalid or you didn't provide the firmware file, you'll be prompted to select another valid firmware file again.</p> <p>The Network Camera will reboot after the upgrade procedure is done. PLEASE NOTE THAT THE IP ADDRESS OF THE CAMERA WILL RESET TO DEFAULT VALUE: 192.168.2.3</p>
Reset to Factory Defaults	<p>Clear all settings in the camera. Please think again before you do this, and then click this button to reset all settings.</p> <p><i>NOTE: IP address will be reset to default value '192.168.2.3' also. You'll need to change the IP address</i></p>

	<i>setting of your computer if the IP address of your computer does not begin with '192.168.2', and subnet mask is not '255.255.255.0', or you'll not be able to connect to this Network Camera again.</i>
Reboot Device	If you found the Network Camera is responding slowly or behaves strange, you can click this button to try to reboot the Network Camera, this may help.
LED Setting	Click 'Turn off LED light' button to switch the LED light of this Network Camera off, so all LEDs on the Network Camera will stop working, in case you don't want other people know the camera is transferring data. You can click this button again to switch LED lights on again.

Click 'Apply' to save settings and make the new settings take effect.

2.4.5 Status

This menu provides all information about this Network Camera, like firmware version, system uptime, date / time, and network information.

System	
✔ Firmware Version :	v1.0 (Apr 28 2010 10:20:19)
✔ Device Uptime :	16 min 13 sec
✔ System Time :	2010/01/01 08:15:59
LAN	
✔ IP Address :	192.168.2.3
✔ Subnet Mask :	255.255.255.0
✔ Gateway :	192.168.2.254
✔ DNS Server :	168.95.1.1
✔ MAC Address :	00:1F:1F:AA:47:A7
✔ HTTP Port :	80
PPPoE	
✔ Link Status :	Disconnected
✔ IP Address :	
✔ Subnet Mask :	
✔ Gateway :	
✔ DNS Server :	

2.4.6 System Log

All activities of this network camera will be logged, and you are allowed to enter 'System Log' menu to view these logs.

System Log

```
1970/01/01 00:00:13 Failed to open PT device!
1970/01/01 00:00:13 System startup [ v1.0 (May  4 2010 18:09:39) ]
2010/01/01 00:00:00 Start Storage Manager.. (PID:67)
2010/01/01 00:00:00 No storage medium found.
2010/01/01 00:00:00 Start Samba Storage Manager.. (PID:68)
2010/01/01 00:00:00 Set microphone volume to 80
2010/01/01 00:00:00 Set Line-Out volume to 80
2010/01/01 08:00:00 embedded av stream server started  PID:72

2010/01/01 08:00:00 Failed to open PT device!
2010/01/01 08:00:00 Starting mpeg4 pipe server for Spook
2010/01/01 08:00:00 Starting h264 pipe server for Spook
2010/01/01 08:00:00 Starting audio pipe server for Spook
2010/01/01 08:00:00 embedded av stream controller started (PID:81)
2010/01/01 08:00:00 Opened /dev/pl_grab successfully
2010/01/01 08:00:01 Opened /dev/pl_enc successfully (MPEG4)
2010/01/01 08:00:01 Opened /dev/pl_enc successfully (MJPEG)
2010/01/01 08:00:01 Opened /dev/pl_264 successfully (H264)
2010/01/01 08:00:01 Opened /dev/pl_enc successfully (MD)
2010/01/01 08:00:01 Accepted a new connection from spook... (mpeg4 video)
2010/01/01 08:00:01 Accepted a new connection from spook... (h264 video)
2010/01/01 08:00:01 Accepted a new connection from spook... (audio)
2010/01/01 08:00:04 Schedule AVI system started (PID:62)
2010/01/01 08:00:04 E-mail schedule system started (PID:61)
2010/01/01 08:00:04 FTP schedule system started (PID:60)
```

2.5 Account

If you wish to allow other people to view the live image captured by this camera, but don't want to allow them to modify system settings, you can give them user-level user name and password, so they can only view the image and can not change any system setting.

This camera supports up to 16 users.



After you selected 'Account', you'll be prompted to input user account information:

Account

♥ User List :

♥ Login :

♥ Password :

♥ Confirm password :

♥ Authority :

user1 : operator

Operator Guest

The descriptions of every setting in this menu will be given below:

Item	Description
User List	Lists all users currently available.
Login	Input the login name (user name) of this account.
Password	Input the password of this user here.
Confirm password	Input the password of this user here again for confirmation.
Authority	Select the privilege of this user: Operator (able to change system settings) or Guest (View images only).
Add	Click this button to add the account.
Modify	Modify an existing user's information. You have to select a user from user list first.
Remove	Remove an existing user. You have to select a user from user list first.

Click 'Apply' to save settings and make the new settings take effect.

Please note: only one user (including administrator) will be able to view the image of Network Camera at the same time.

2.6 SDHC

...



After you selected 'System Info.', a sub-menu will appear. There are 4 sub-menus available here:



Please click the SD card setting you wish to set then refer to instructions given below:

2.6.1 Status

Here shows the remaining card space for you.

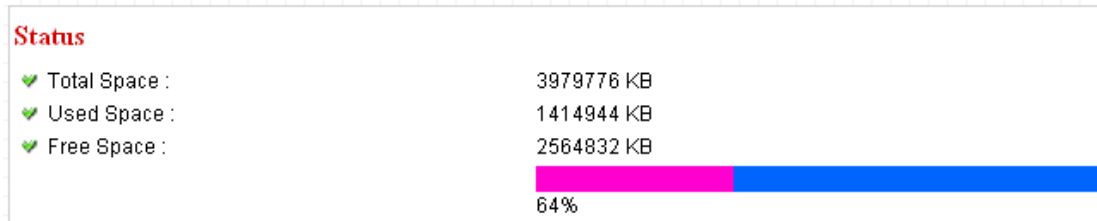

2.6.2 Space Alarm

When you're using SD card to store captured image and video clip, you can have this camera to send an E-mail to you when there's only little remaining space left on SD card.

Space Alarm

Recipient E-Mail Address :
 E-Mail Subject :
 SMTP Server :
 Sender E-Mail Address :
 SMTP Port :
 SMTP enable SSLv2/v3 function : Enable Disable
 SMTP Authentication : Enable Disable
 User Name :
 Password :
 Reserved Space : MB

Please note: If you have set E-mail settings in 'Motion Picture' function, you can click 'Copy Mail Config' button to use the same setting. However, you can use a different setting here.

The descriptions of every setting in this menu will be given below:

Item	Description
Recipient E-Mail Address	Input the E-mail address you wish to receive space alarm.
E-Mail Subject	Input the title of space alarm E-mail.
SMTP Server	Input the SMTP server address you wish to use to send E-mail.
Sender E-Mail Address	Input the sender E-mail address of the space alarm E-mail.
SMTP Port	You can set port number according to your mail server.
SMTP enable SSLv2/v3 function	Select 'Enable' if your SMTP server supports SSLv2/v3 such as gmail.

SMTP Authentication	Select 'Enable' if the SMTP server you're using requires authentication, and input the username and password below; If the SMTP server you're using does not require authentication, select 'Disable' here. If you're not sure, ask your ISP or network administrator.
User Name	Type the user name of the user who has the mail account. This setting is necessary when the SMTP server which sends e-mails performs authentication.
Password	Type the password of the user who has the mail account. This setting is necessary when the SMTP server which sends e-mails performs authentication.
Reserved Space	Select the amount of SD card space which will be reserved and will not be used from dropdown menu.

Click 'Apply' to save settings and make the new settings take effect.

You can click 'Send a test email' button to send a test E-Mail by the configuration you set here.

2.6.3 File Management

You can use this menu to manage the files stored on SD card.

File Management

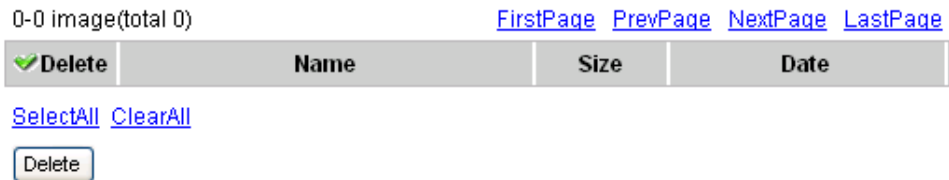

The descriptions of every setting in this menu will be given below:

Item	Description
FirstPage	Jump to first page of file list.
PrevPage	Jump to previous page of file list.
NextPage	Jump to next page of file list.
LastPage	Jump to last page of file list.
SelectAll	Select all files in this page.
ClearAll	Clear all files in this page.
Delete	Delete selected files.

Chapter III: Using Surveillance Software

3-1 Installing Network Camera Surveillance Software

The Network Camera surveillance software provides various functions like video recording, after this software is installed, you can use your Network Camera to safeguard your property. Please follow the following instructions to install the surveillance software.

1. Double click the setup file located in 'xxx' folder in supplied CD-ROM, when the following window appears, click 'Next'.

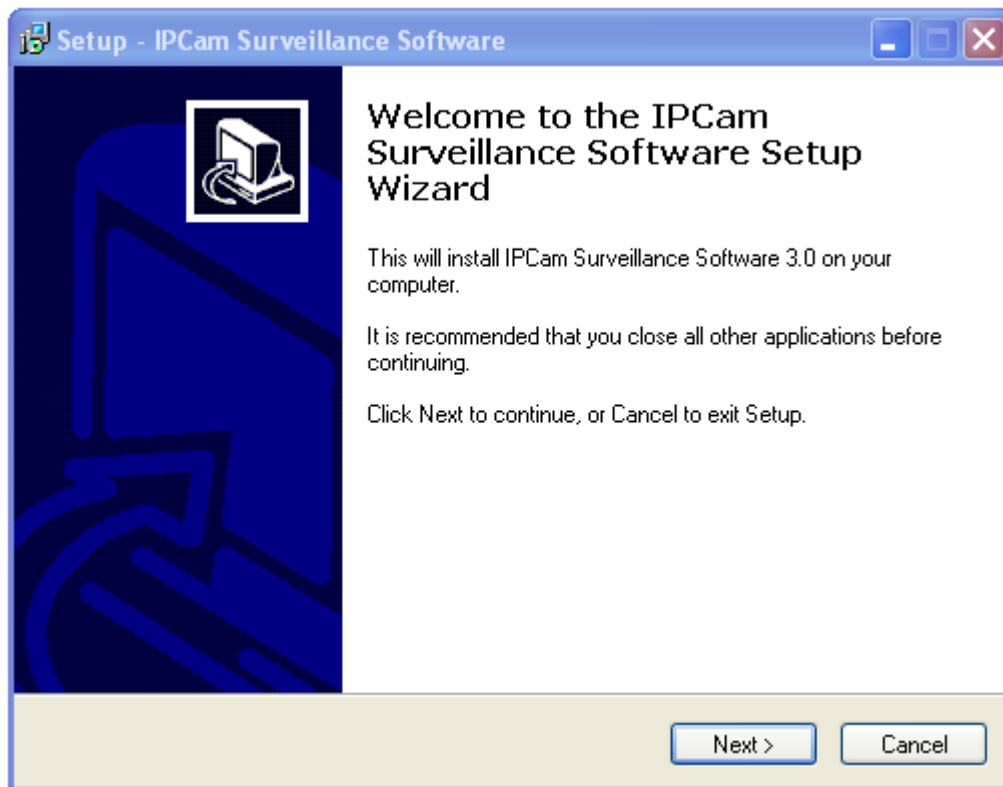

2. You can specify the destination folder of software installation, you can just use the default folder, and click 'Next' to continue.

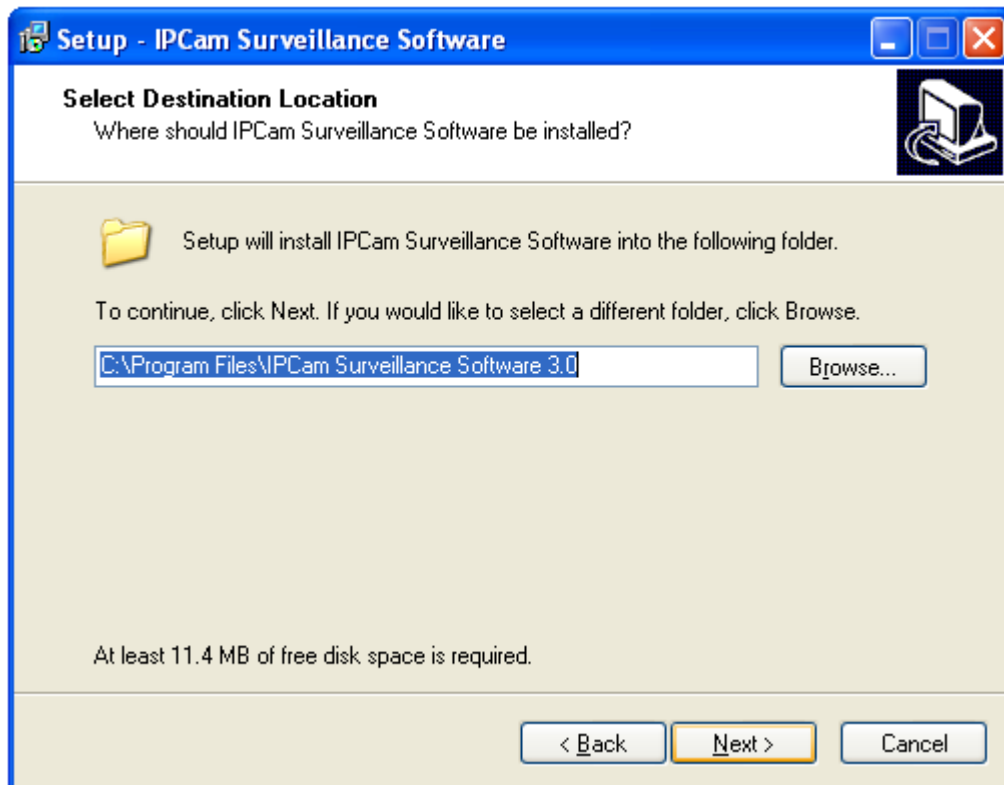

3. If you need installation program to create a desktop icon or a quick launch icon for you, click all items you need here, then click 'Next' to continue.

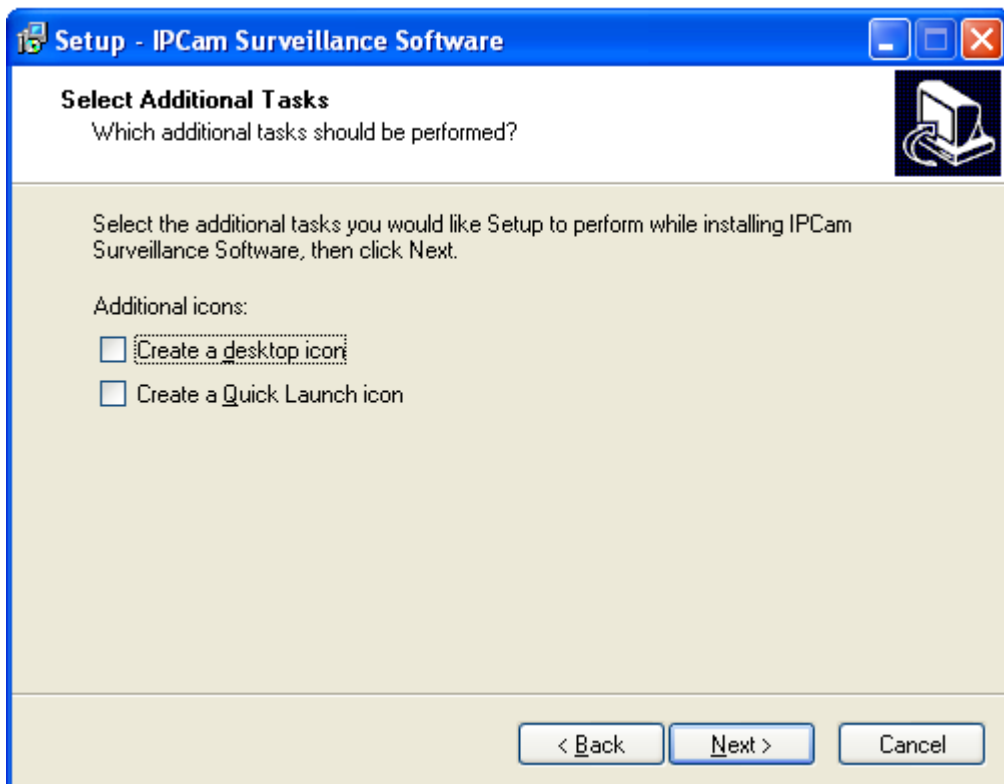

4. Here lists all options you chose in previous steps, if everything's correct, click 'Install' to start installing procedure, or click 'Back' to go back to previous step to modify installing settings.

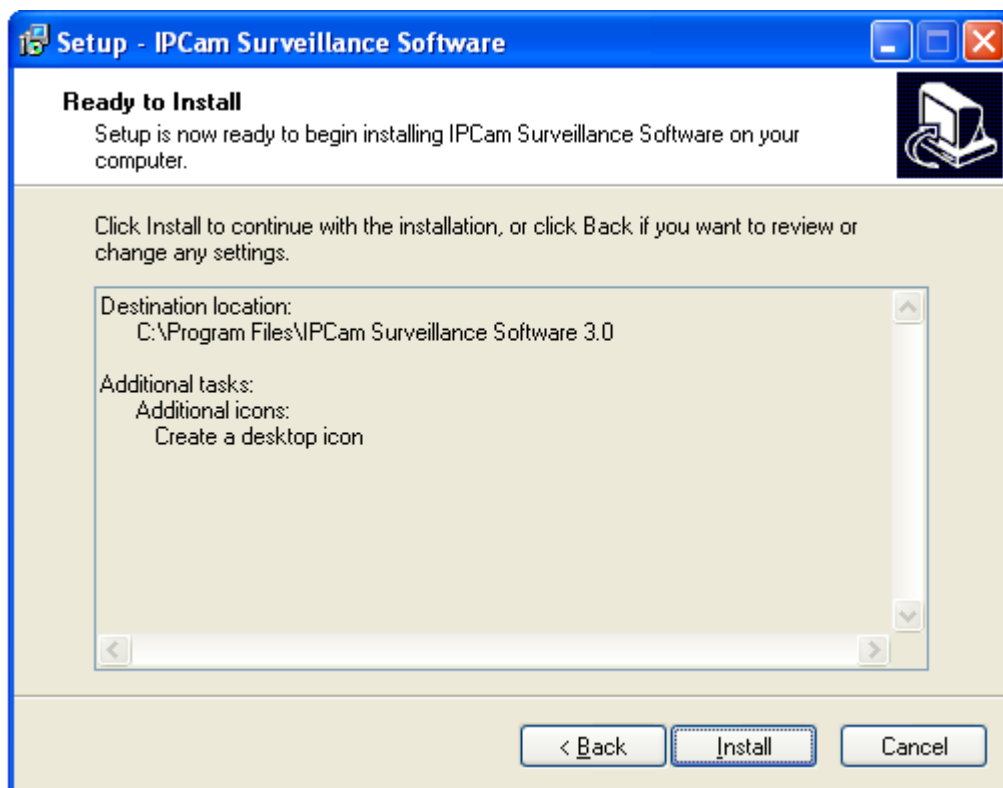

5. The installing procedure will take some time, please be patient.

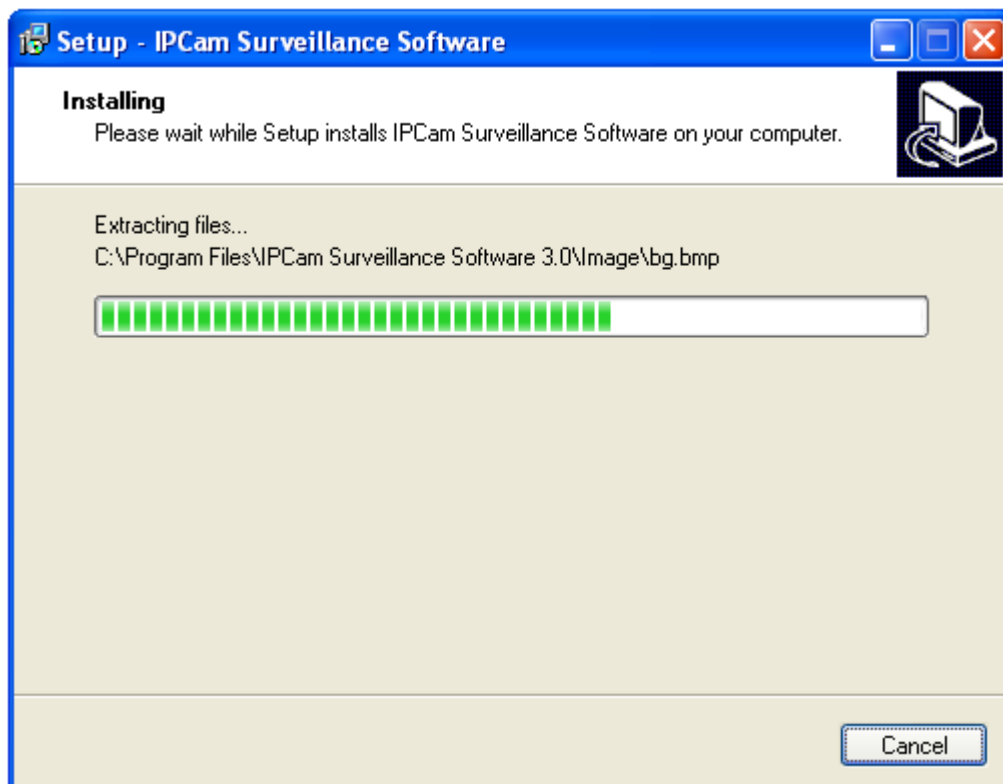

6. When you see this window, it means the software installing procedure is complete. Please click 'Finish' to finish the procedure (Network Camera surveillance software will start after you click 'Finish' button, if you want to start it later, uncheck 'Launch IPCam Surveillance Software' box).

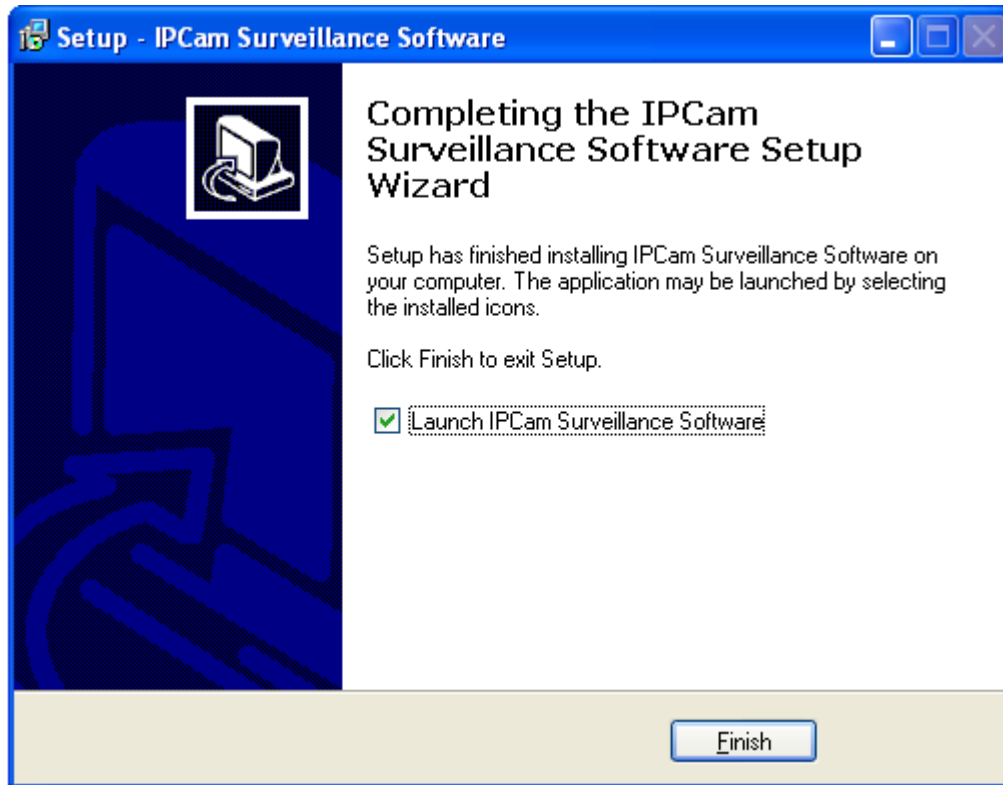

3-2 Using Network Camera surveillance software

You can click 'IPCam Surveillance Software' icon from desktop, quick launch bar, or start menu to start the Network Camera surveillance software.







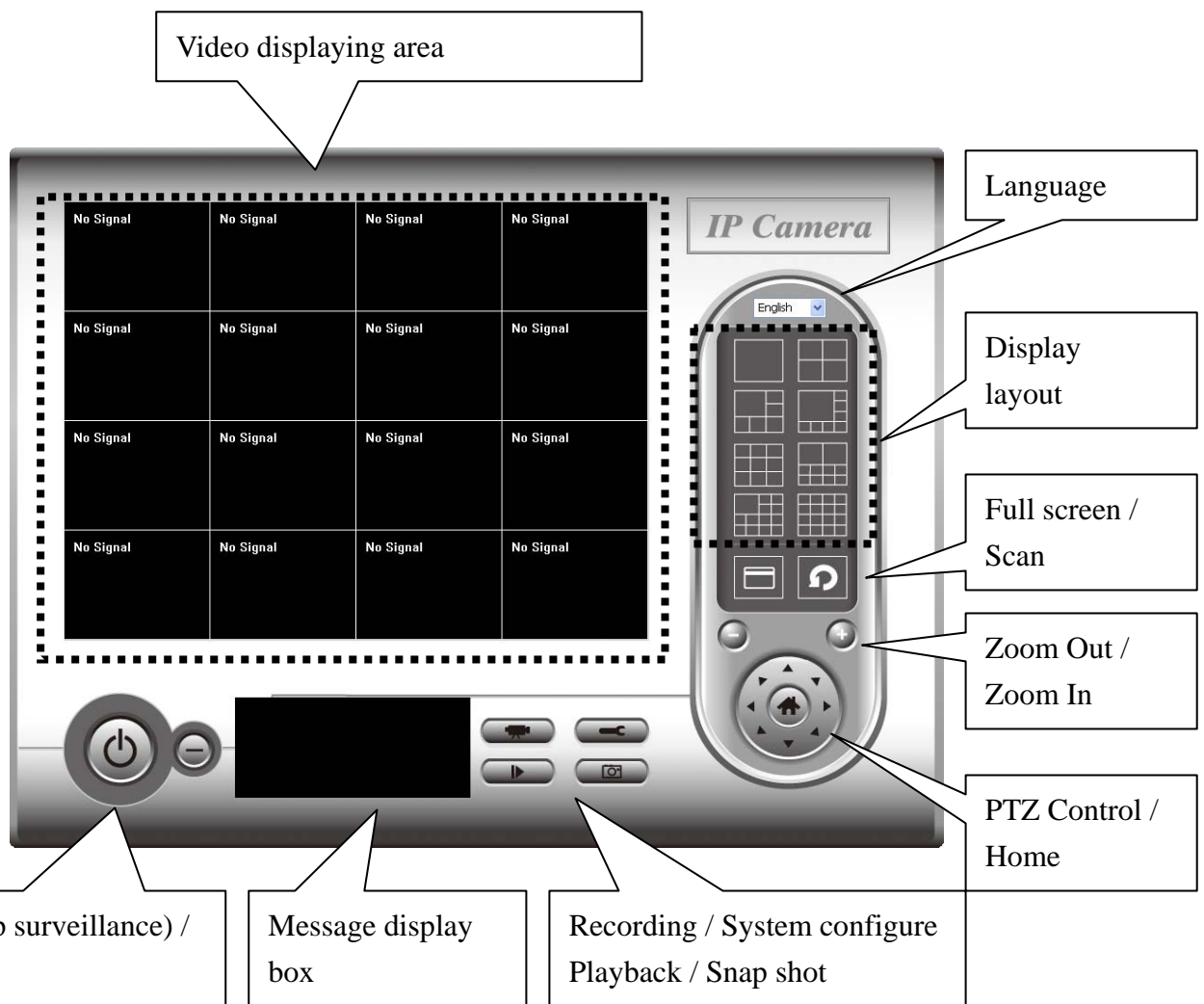



Before you start:





Network Camera surveillance software will only work when your monitor's resolution is '1024 x 768'. Please change the resolution before you use Network Camera surveillance software, or it won't

Here are descriptions for all components of Network Camera surveillance software:



You can put the mouse cursor on a certain component and see its button name, and here're detailed descriptions of all buttons:

Item	Description
Video displaying area	The image of all connected cameras will be displayed here.
Language	Select a language from this dropdown menu to change display language.
Display layout 	Change camera image display layout (Click a layout icon to change camera display layout). There are 8 kinds of available display layouts.
Full screen 	Click this button to switch to full screen mode (only display all camera's image), press 'ESC' key to quit full screen mode.
Scan 	Click this button and the Network Camera surveillance software will switch displaying the image of all connected camera automatically. Click this button once to activate scan function (scan icon will become blue ) , click again to stop scanning (scan icon will become white ) .
Zoom out 	Zoom-out (To see more objects). This function is only available for supported cameras.
Zoom In 	Zoom-in (Too see more details). This function is only available for supported cameras.
PTZ control 	There are 8 directions in PTZ control ring. If the camera you connect support PTZ, you can use PTZ control ring to change the direction that camera points to. This function is only available for supported cameras.
Home 	Click this button to return the camera to 'Home' (default) position. This function is only available for supported cameras.
Recording 	Start video recording.
Configure 	Software / camera configuration.

<p>Playback</p> 	<p>Playback a recorded video file.</p>
<p>Snapshot</p> 	<p>Take a snapshot of current camera.</p>
<p>Message display</p>	<p>Displays all system messages like camera is disconnected etc.</p>
<p>Close window (stop surveillance)</p> 	<p>Terminates Network Camera surveillance software.</p>
<p>Minimize window</p> 	<p>Minimizes Network Camera surveillance software window.</p>
<p>Video displaying area</p>	<p>Displays the image of all cameras by the display layout you selected.</p>

3-3 Configure Network Camera surveillance software

3-3-1 Configure cameras

Before you use this Network Camera surveillance software, you must configure the camera(s) you wish to connect. Please click 'System configure' button  and a popup menu will appear:

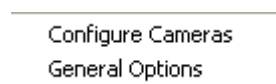

Please select 'Configure Cameras' to configure cameras:

Note: If you're prompted by a windows security alert which asks you if you want to block 'IPCamViewer' program, please click 'Unblock' button, of Network Camera surveillance software will not be able to function correctly.



3-3-1-1 'Camera' tab

In this tab you can configure all cameras you wish to connect. Up to 16 cameras can be connected simultaneously:

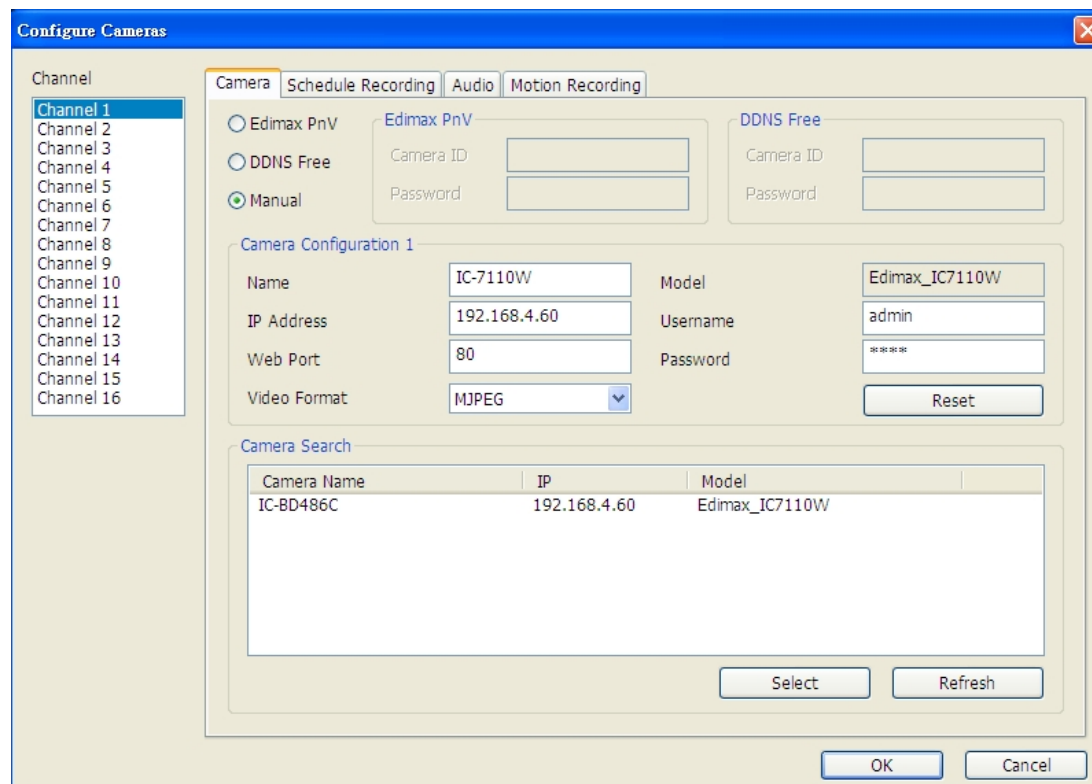

Here are the descriptions of all setting items:

Item	Description
Channel	Select the channel number you wish to set.
Camera Search	All cameras found on your local network will be displayed in 'Camera Search' box.
Select	Select a camera listed in 'Camera Search' box, and click 'Select' button to fill all parameters of selected camera in every camera configuration fields.
Refresh	Rescan all cameras on your local network. If you didn't see the camera you expected in 'Camera Search' box, or new cameras has been joined to your local network after last scan.
Name*	Input the name of camera here. Default value is the first 6 bytes of camera's MAC address, you can change the

	name of camera so you can remember the camera's location of purpose easily.
Model	Displays the model of selected camera, this field can not be changed.
IP*	Input the IP address of camera.
Username*	Input the user name of camera.
Web Port*	Input the web port of the camera. By default it's '80'.
Password	Input the password of camera. Default value is '1234'. You should change the password if you changed the password of selected camera.
Video Format**	Select the video encoding format of this camera (MJPEG or MPEG4).
Reset	Clear all fields in 'Camera Configuration' section.
OK	Save settings in this tab.
Cancel	Discard all settings in this tab.

*: It's recommended to use 'Select' button to fill the content of this field.

** : Only available for cameras support this function.

After you've set all channels you wish to set, click 'OK' to save settings, and if everything's correct, you'll see the camera's image in Network Camera surveillance software's main menu:



3-3-1-2 Schedule Recording

In this tab, you can setup scheduled video recording, so you can record the video captured by all cameras you have by a pre-defined schedule.

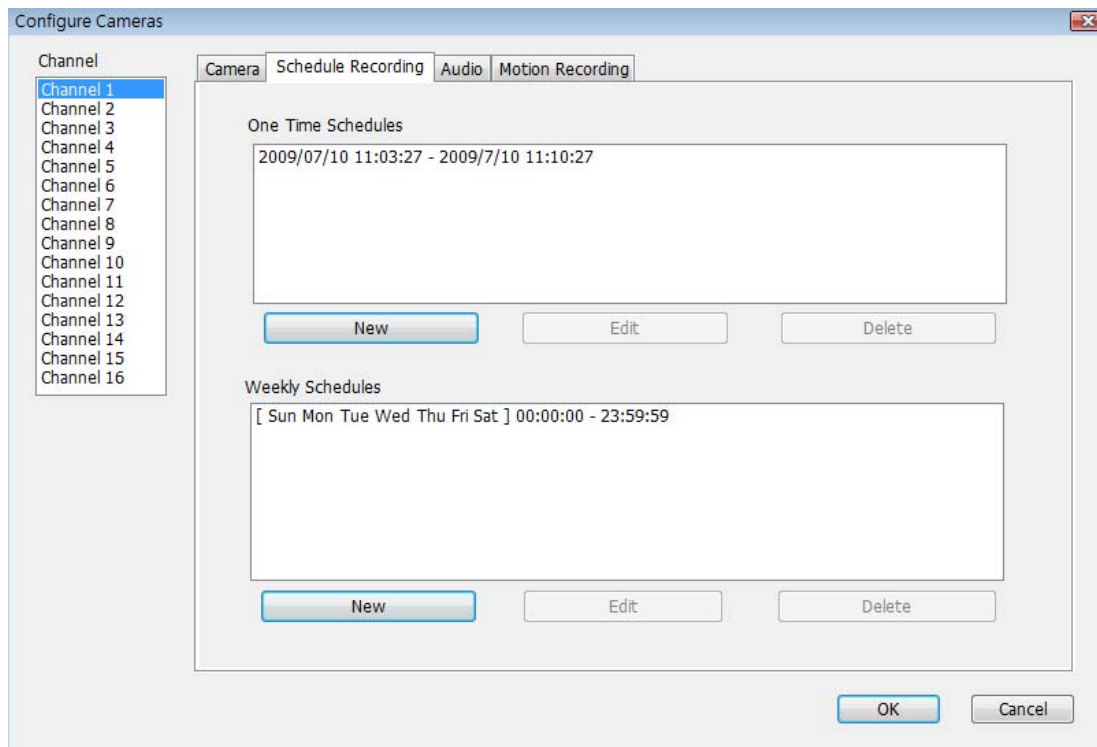

Here are the descriptions of all setting items:

Item	Description
Channel	Select the channel number you wish to set.
One Time Schedules	You can specify the one-time schedule for selected camera; this schedule will be executed once only.
New (One Time Schedules)	Click this button and a new window will appear:

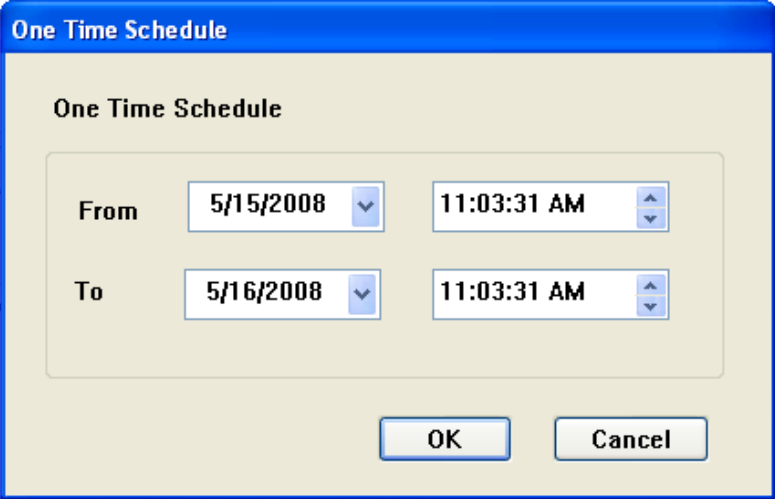
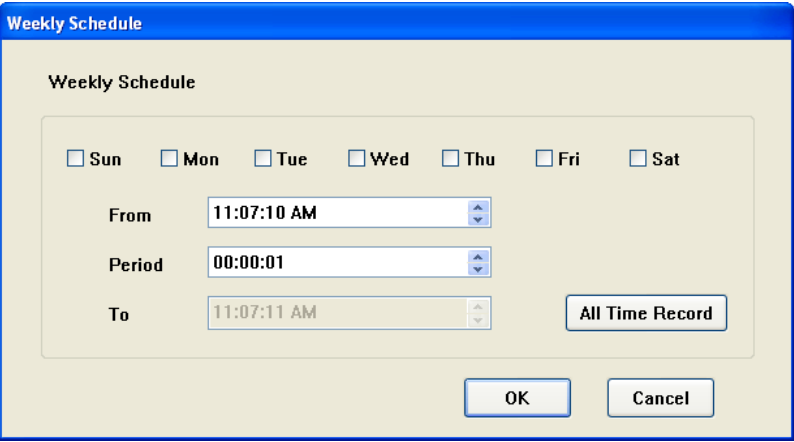
	 <p>Please specify the time duration of this one-time schedule (the date and time of 'From' and 'To'), then click 'OK' to save settings.</p> <p>Please note you must set a schedule that will be happened in the future, you can not set a schedule in the past.</p>
Edit	<p>You can modify a scheduled recording item. Select a schedule in 'One Time Schedules' list, and click 'Edit' button to edit the start and end time of this schedule.</p>
Delete	<p>Delete a selected schedule item.</p>
New (Weekly Schedules)	<p>Click this button and a new window will appear:</p>  <p>You can define recording schedule that will be executed at the specified time of certain weekday(s) in a week.</p>

	<p>Please check all weekdays that applies, and set the start time in 'From' field. You can set the duration of video recording in 'Period' field (format is HH:MM:SS), and the end time will be calculated automatically and displayed in 'To' field. You can also click 'All Time Record' button to define a recording schedule that will be executed every weekday, from 12:00:00AM to 11:59:59PM.</p> <p>Click 'OK' to save changes.</p>
Edit	You can modify a scheduled recording item. Select a schedule in 'One Time Schedules' list, and click 'Edit' button to edit the start and end time of this schedule.
Delete	Delete a selected schedule item.
OK	Save settings in this tab.
Cancel	Discard all settings in this tab.

3-3-1-3 Audio

For cameras that support audio, you can use this tab to decide if you wish to hear the audio captured by selected camera.

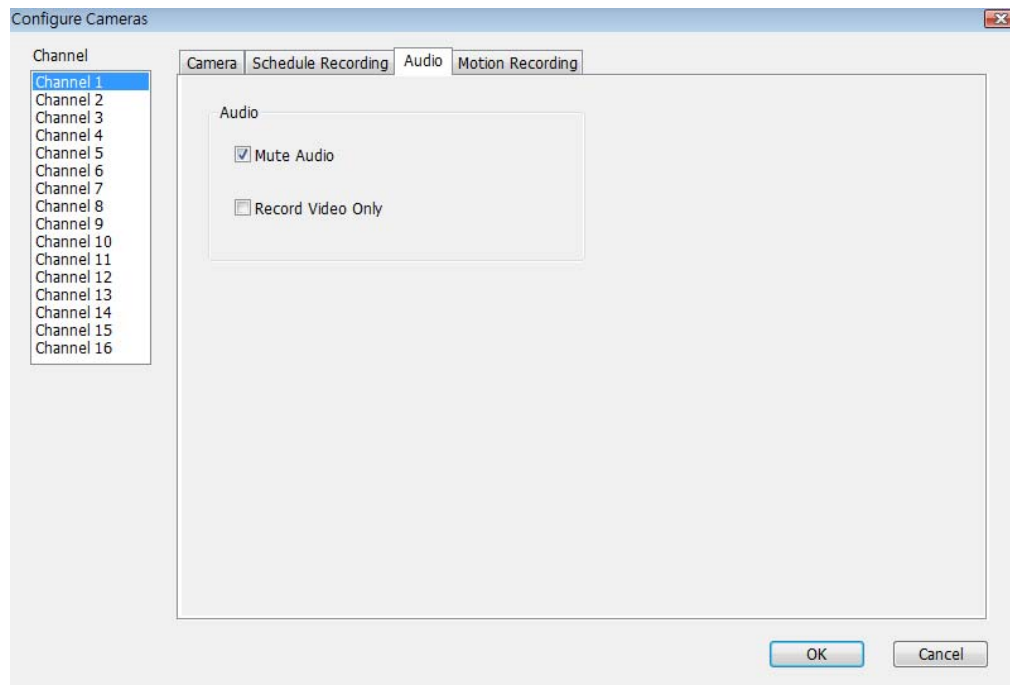

Here are the descriptions of all setting items:

Item	Description
Channel	Select the channel number you wish to set.
Mute Audio	Check this box and the Network Camera surveillance software will not play the audio captured by this camera.
Record Video Only	Check this box and the Network Camera surveillance software will not record the audio captured by this camera.
OK	Save settings in this tab.
Cancel	Discard all settings in this tab.

3-3-1-4 Motion Record

With this function activated, only motions captured by the camera will be recorded, so you don't have to waste hard disk storage space on images you don't need to pay attention to.

WARNING: For applications that security is highly concerned, it's not recommended to use this function since some tiny changes you may need to know may not be able to trigger the camera and the camera will not start recording.

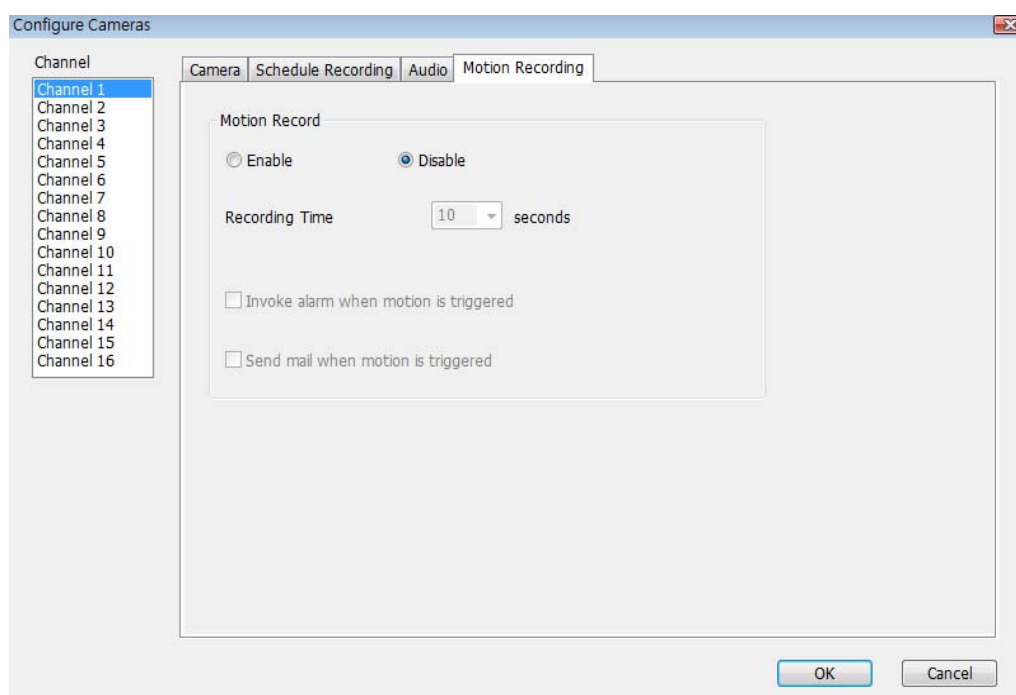

Here are the descriptions of all setting items:

Item	Description
Channel	Select the channel number you wish to set.
Enable	Enable motion record function.
Disable	Disable motion record function.
Recording Time	Select the time duration that camera will record when a motion has been detected from dropdown menu in seconds.
Invoke alarm when motion is	Send an alarm when a motion has been detected by the camera.

triggered	
Send mail when motion is triggered	Send an email to a pre-defined address when a motion has been detected by the camera.
OK	Save settings in this tab.
Cancel	Discard all settings in this tab.

3-3-2 General Settings

You can set system-wide settings of this Network Camera surveillance software in this menu.

3-3-2-1 'General' tab

All general settings like file storage directory and recording spaces can be set here.

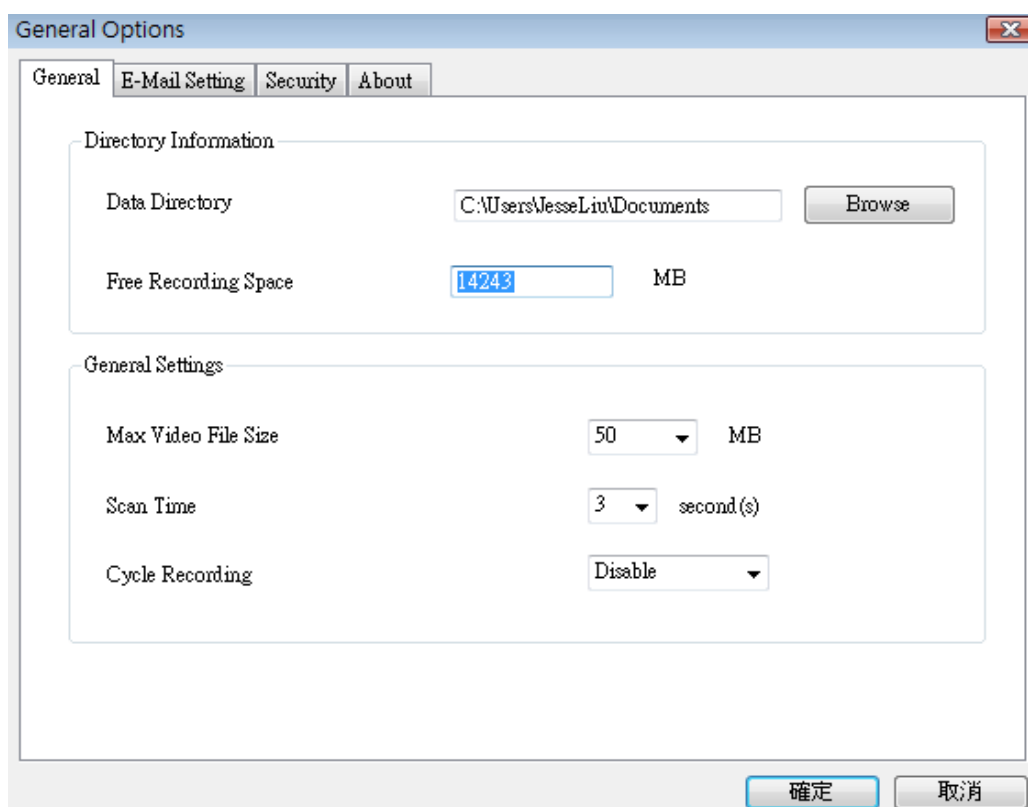

Here are the descriptions of all setting items:

Item	Description
Data Directory	Set the directory (folder) you wish to store the recorded video and captured image. You can click 'Browse' button to pick a directory in your hard disk.
Free Recording Space	Displays remaining storage space.
Max Video File Size	Defines the maximum file size of every video file. When the size of file exceeds this value, Network Camera surveillance software will open another file to record the

	video.
Scan Time	Define the time period to pause between every camera switch when you activate 'Scan' function.
Cycle Recording	You can decide the behavior when hard disk space is full: Disable: Do not overwrite recorded video files. Enable: Overwrite recorded video files.
OK	Save settings in this tab.
Cancel	Discard all settings in this tab.

3-3-2-2 'E-Mail Setting' tab

If you want to use motion detection function and wish to get an email that contains the image captured by the camera, please setup your email related parameters here first.

Here are the descriptions of all setting items:

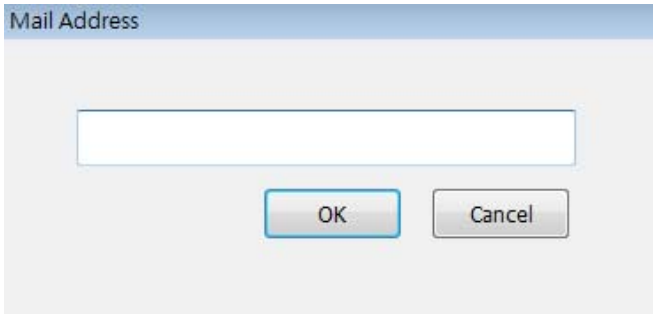
Item	Description
E-Mail Subject	Specify the subject of sending email.
Recipient E-Mail Address	Here lists all email addresses you set.
New	Click this button and you'll be prompted to input the email address. Click 'OK' to save changes. 

Edit	Select an email address from 'Recipient E-Mail Address' box, and click 'Edit' to edit the email address.
Delete	Delete selected email address.
Sender E-Mail Address	Specify the email address of email sender.
SMTP Server	Specify the IP address or host name of the SMTP server you wish to use. For most of ISPs they will only allow its subscriber to use their SMTP server, if you don't know which SMTP server you should use, please refer to the setting of your email software or ask your ISP / network administrator.
SMTP port	Specify the port number of the SMTP server you wish to use here. By default (and the setting of most of SMTP servers) it's '25'.
SMTP Auth	Select 'Enable' if your SMTP server requires authentication, select 'Disable' if it's not required. If you don't know if your SMTP server requires authentication, please refer to the setting of your email software or ask your ISP / network administrator.
SMTP Account	Input the SMTP account (username) of your SMTP server here. In most cases, it's the same with your POP3 username (the one you used to receive email). Please refer to the setting of your email software or ask your ISP / network administrator if you're not sure about this.
SMTP Password	Input the SMTP password of your SMTP server here. In most cases, it's the same with your POP3 password (the one you used to receive email). Please refer to the setting of your email software or ask your ISP / network administrator if you're not sure about this.
OK	Save settings in this tab.
Cancel	Discard all settings in this tab.

3-3-2-3 Security

If you don't want other people to access this Network Camera surveillance software, you can set a password to protect it.

You'll need to input the password every time you wish to use this Network Camera surveillance software:

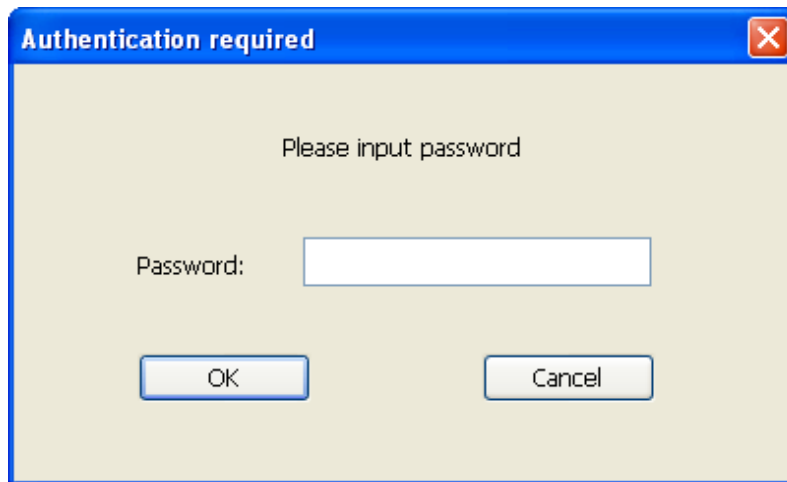

To set password, please use 'Security' tab in 'General Options' menu:

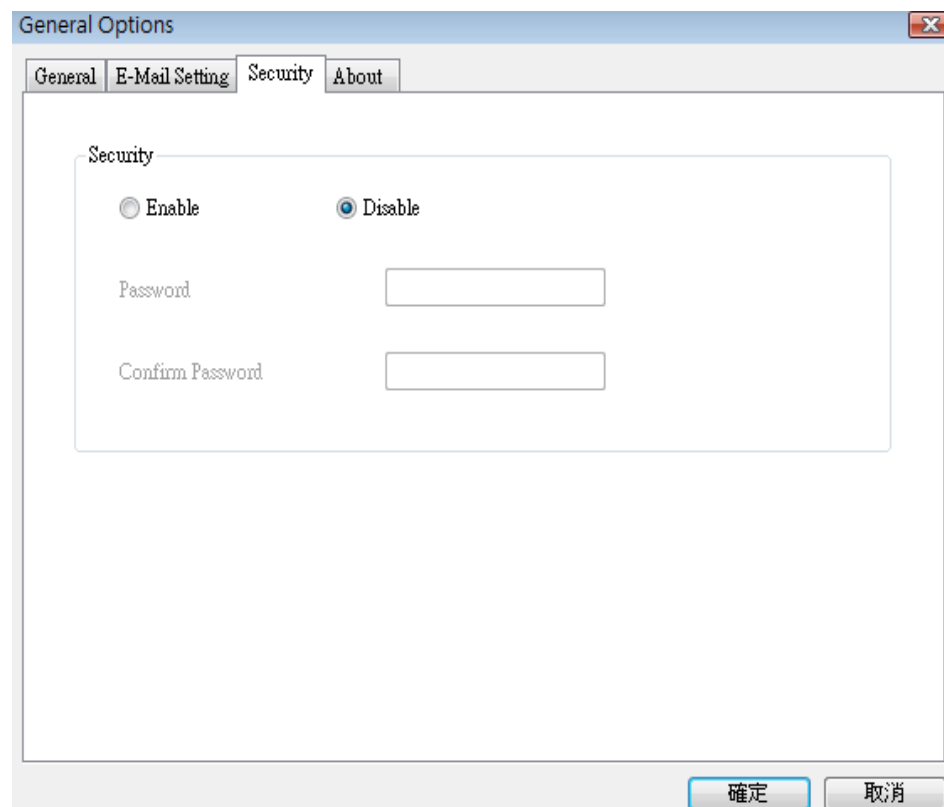

Here are the descriptions of all setting items:

Item	Description
Enable	Requires password authentication when this software starts.
Disable	Password authentication is not required when this software starts.
Password	Input the password you wish to use here.
Confirm Password	Input the password you wish to use here again.

3-3-2-4 About

This tab shows the version number of the Network Camera surveillance software you're using.

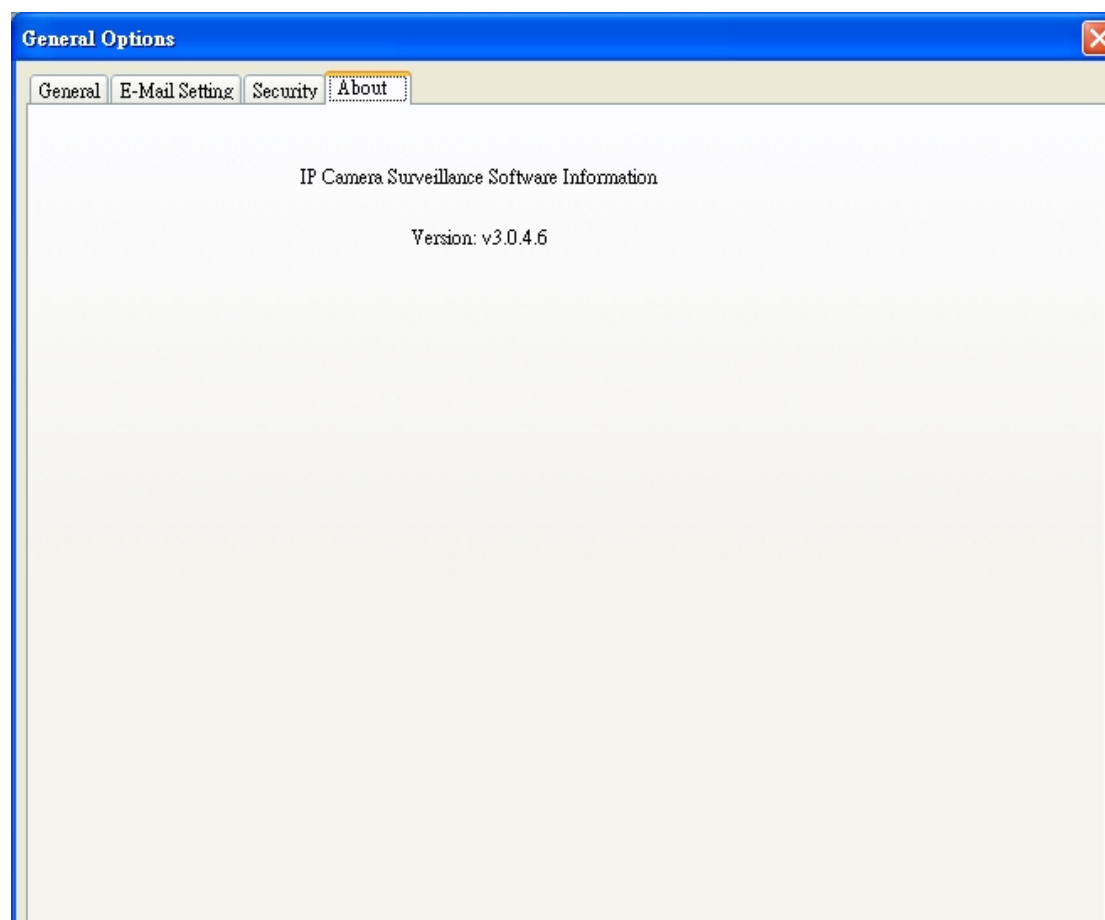

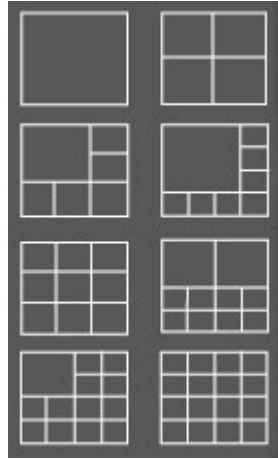

3-4 Change Display Layout

This Network Camera surveillance software provides 8 kinds of display layout:

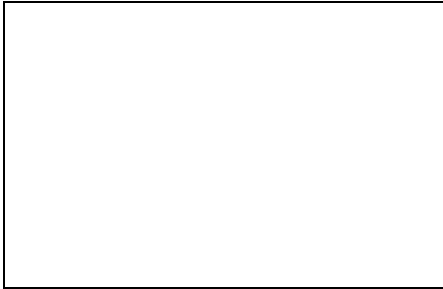
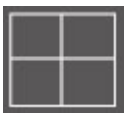
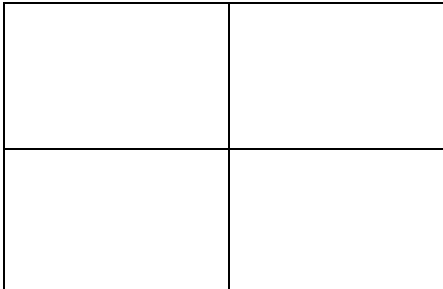

Every layout displays different number of camera and camera arrangement, you can click the icon that presents a specific kind of layout, and the video displaying area will change accordingly.

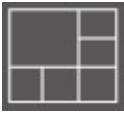
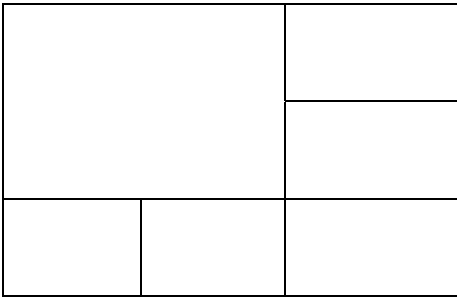
<p>Layout style 1: 1 Camera only</p> 	<p>Displays the video of 1 camera only.</p> 
<p>Layout style 2: 4 Cameras</p> 	<p>Displays the video of up to 4 cameras.</p> 

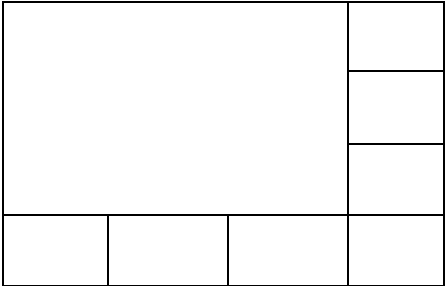
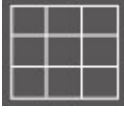
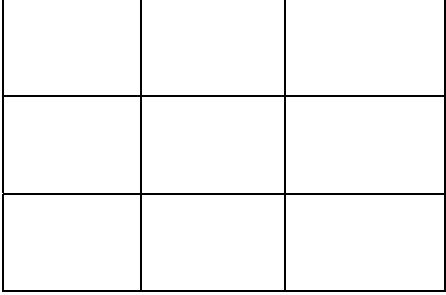
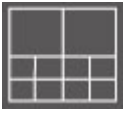
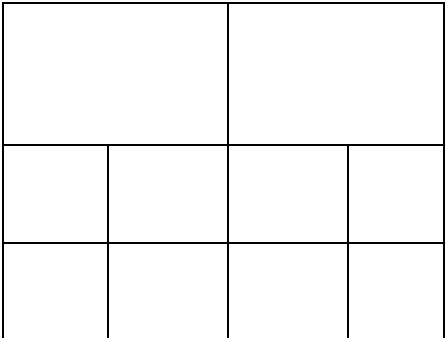
<p>Layout style 3: 6 Cameras</p> 	<p>Displays the video of up to 6 cameras.</p> 
<p>Layout style 4: 8 Cameras</p> 	<p>Displays the video of up to 8 cameras.</p> 
<p>Layout style 5: 9 Cameras</p> 	<p>Displays the video of up to 9 cameras.</p> 
<p>Layout style 6: 10 Cameras</p> 	<p>Displays the video of up to 10 cameras.</p> 

Layout style 7: 13
Cameras

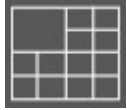

Displays the video of up to 13 cameras.

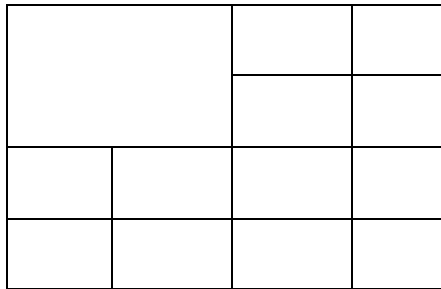

Layout style 8: 16
Cameras

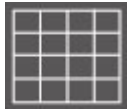

Displays the video of up to 16 cameras.

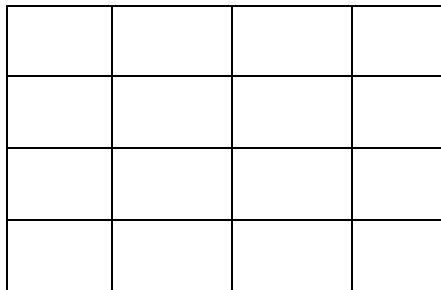

3-5 Full-screen mode

If you want to use all available spaces on your monitor to display surveillance image, you can click 'Full Screen' button to switch display mode to full-screen mode.





To exit full-screen mode, press 'ESC' key.

3-6 Scan

If you have more than one camera configured, and you wish to switch the displaying image between cameras, you can click 'Scan' button to switch between all configured cameras.

NOTE: If a camera is configured but disconnected, it will still be displayed in a scan sequence (you'll see nothing and you'll see 'Disconnected' text displayed at the upper-left corner of display image).





Click 'Scan' button once to activate scan function (scan icon will become blue ) , click again to stop scanning (scan icon will become white ).

3-7 Zoom-in / Zoom-out

For cameras that support zoom-in / zoom-out function, you can use this function to see more objects that fall in the scope of camera's view, or enlarge the image size of a certain object to see its detail.



Please select a camera in video displaying area by clicking on its image, then click  button to see more objects that fall in the scope of camera's view, or click  to enlarge the image size of a certain object to see its detail (Before zoom-in, you may need to use PTZ buttons - described in next section) to find an object you wish to see its detail).

3-8 PTZ

For cameras that support pan - tilt function (but this model doesn't support PTZ function), you can change the position that camera points to, to see different places that fall in the scope of camera's view.



Please select a camera in video displaying area by clicking on its image, and then click the directions you wish the camera to move to (total 8 directions available). Click 'Home' button (🏠) to return to camera's home (default) position.

3-9 Snapshot

You can take a snapshot of selected camera and save it to 'Snapshot' sub-folder of pre-defined data directory.



Click snapshot button once to take a snapshot; you can take as much snapshot as you want before hard disk is full.

3-10 Recording

You can start video recording of selected camera manually by clicking 'Start Recording' button:



When recording starts, you'll see a message displayed in message displaying box like '1/1 10:00:00, Camera 2 Start Manual', which means camera 1 starts recording manually on 1/1 at 10:00:00.

To stop recording, click 'Start Recording' button again, and you'll see a message displayed in message displaying box like '1/1 10:00:00, Camera 2 Stop Manual'.

3-11 Video Playback

You can playback all recorded video by clicking this button.

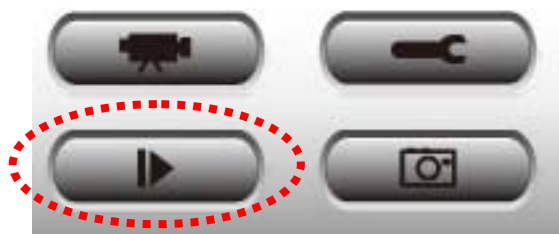

A new window will appear:

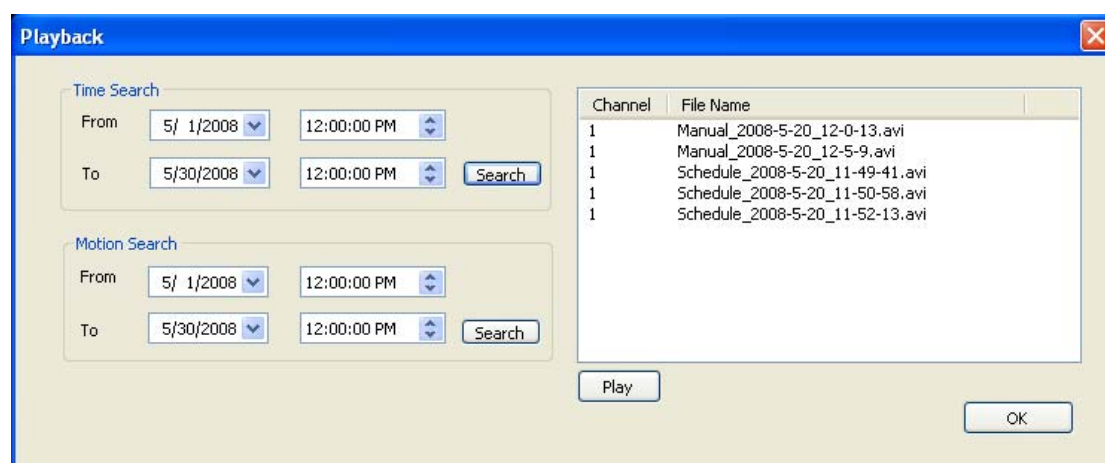

You have to search the video file before you can play it. There are two kinds of video search: Time Search (search all videos file that falls in a specific period of time) and Motion Search (search all videos recorded by motion detection function and falls in a specific period of time).

Please define the start and end date / time of the time period you wish to search, and then click 'Search' button (of 'Time Search' of 'Motion' Search'). All found videos will be displayed, select the video you wish to play and click 'Play' button to playback.

Chapter IV: How to Access the Network Camera Remotely with iPhone & Android Phones

IC-3100 series features smart phone support for iPhone users and Android phone users to monitor their home using Edimax Network-Cameras.

Please check following instruction for installation. The following instruction applies to all Edimax routers

Step1:

Ensure My-PC is Internet-ready via Router

Step 2:

Check with your ISP (Internet Service Provider) whether a Public and fixed IP address is assigned to you. An IP address is like an unique phone number that is totally different from all the others' for calling a particular person. You could browse the Internet or monitor your home over the Internet with iPhone by using this unique IP address. Therefore, an unique IP address is a Public and fixed IP address. With this, it's much easy for iPhone monitoring your home. For example, an IP address looks like numbers separated with a dot as: 192.168.2.3

(1) Fixed and public IP address:

All IP addresses different from the following are fixed and public IP address

10.0.0.0 - 10.255.255.255

172.16.0.0 - 172.31.255.255

192.168.0.0 - 192.168.255.255

Write down this IP address and go to Step 3. In this guide, we use a hypothetical IP address, 61.61.61.1 (yours is different)

(2) Dynamic IP address

If your ISP service staff cannot tell you what IP address is for you, you can still monitor your home with iPhone, but it turns more complicated.

Your IP address for browsing Internet will change by hours or by days.

Over 90% chance, you may get a dynamic IP address. There is a solution called Dynamic DNS (DDNS) for free. With this, you could register a name like <http://my-name.dyndns.org> for example to find out Edimax network camera

in the I-Phone. To apply for this, refer to the Appendix “How to apply for a free DNS account in the <http://www.dyndns.org>” In this guide, we assume you have already got <http://my-name.dyndns.org>. (yours may vary) and go to Step 3.

Step 3:

Configure the 1st Camera based on the following:

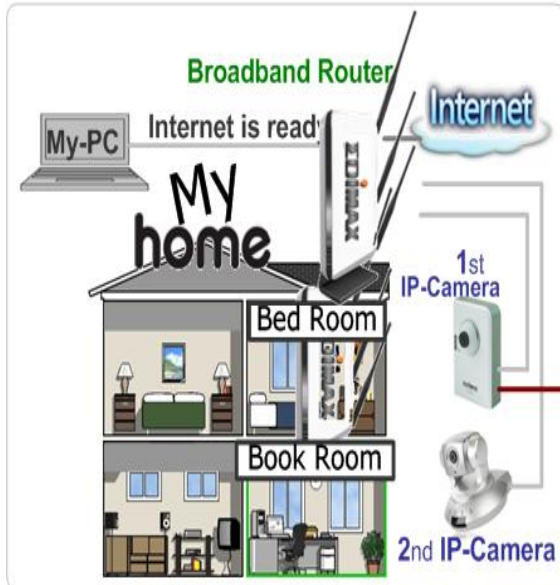

Configuration for the 1st camera

- LAN Audio/Video E-mail & FTP
- 1
- Network Type DHCP Static IP Address
- IP Address 2 Change the IP to 192.168.2.10
- Subnet Mask
- Gateway This is the IP of Edimax router
- Primary DNS
- Second DNS
- AV Control Port 3
- Web port "Web port" 80 is preserved for the 1st camera

Configure the 2nd Camera based on the following:

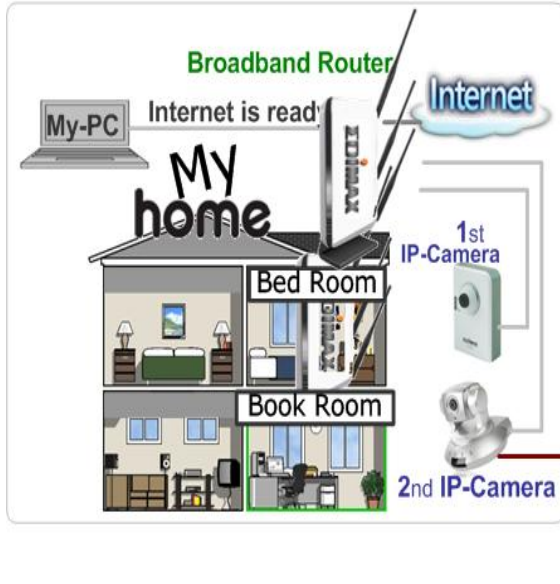

Configuration for the 2nd camera

- LAN Audio/Video E-mail & FTP
- 1
- Network Type DHCP Static IP Address
- IP Address 2 Change the IP to 192.168.2.20
- Subnet Mask
- Gateway This is the IP of Edimax router
- Primary DNS
- Second DNS
- AV Control Port 3
- Web port "Web port" 82 is preserved for the 2nd camera

Configure the Broadband Router based on the following:

Quick Setup | General Setup | EZ View | Status | Tools

Home / General Setup / Advanced Settings / NAT / Virtual Server

1 Go to "Virtual server" setup page

Enable Virtual Server

Private IP	Computer name	Private Port	Type	Public Port	Comment
192.168.2.10	<< -----Select----- >>	80	Both	80	1st-camera

2 Enter required information for the 1st camera and click "Add"

Enable Virtual Server

Private IP	Computer name	Private Port	Type	Public Port	Comment
192.168.2.20	<< -----Select----- >>	82	Both	82	2nd-camera

3 Enter required information for the 2nd camera and click "Add"

Current Virtual Server Table:

NO.	Computer name	Private IP	Private Port	Type	Public Port	Comment	Select
1		192.168.2.10	80	TCP+UDP	80	1st-camera	
2		192.168.2.20	82	TCP+UDP	82	2nd-camera	

4 Click "Apply"

4.1 iPhone App Installation

(1) Please download 'Ediview' application from Apple's Appstore

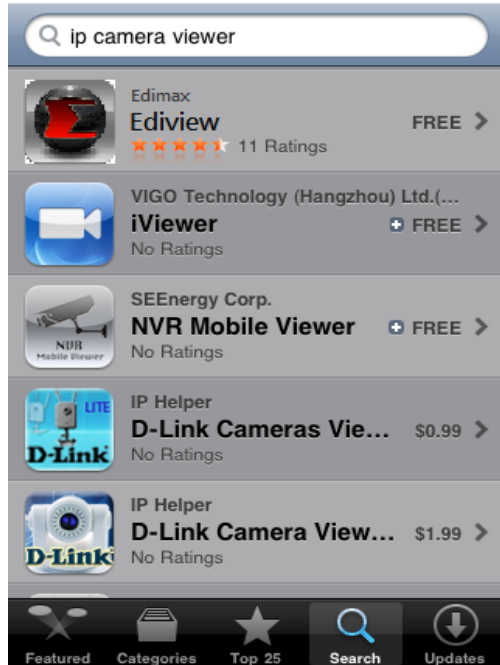

(2) You can launch EdiView by clicking 'EdiView' icon. You'll see welcome screen and please wait for few seconds



(3) When you launch EdiView, it will attempt to connect to existing configured network cameras. Please make sure you're connected to wireless access

point if your Edimax network camera is located on your local area network.

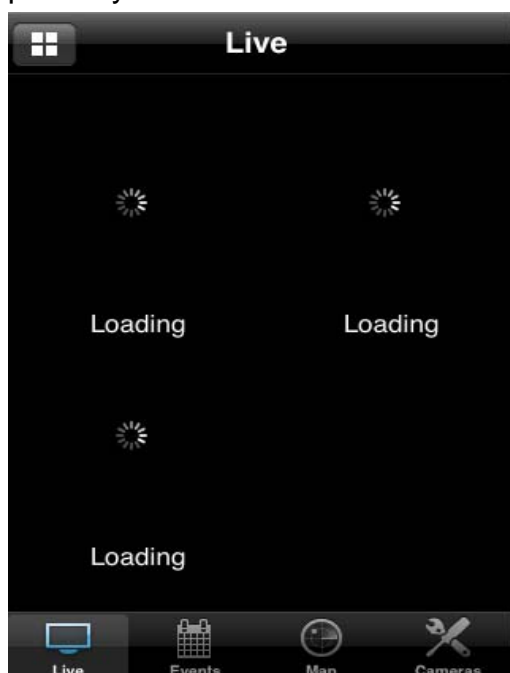

If you want search for network cameras on your local area network, or you want to add an Edimax network camera on Internet, please click 'Cameras' button to abort and setup network camera manually

(4) To view more than 4 network camera's live image on your iPhone, click  button on upper-left corner, and you can view up to 12 network camera's live image at the same time

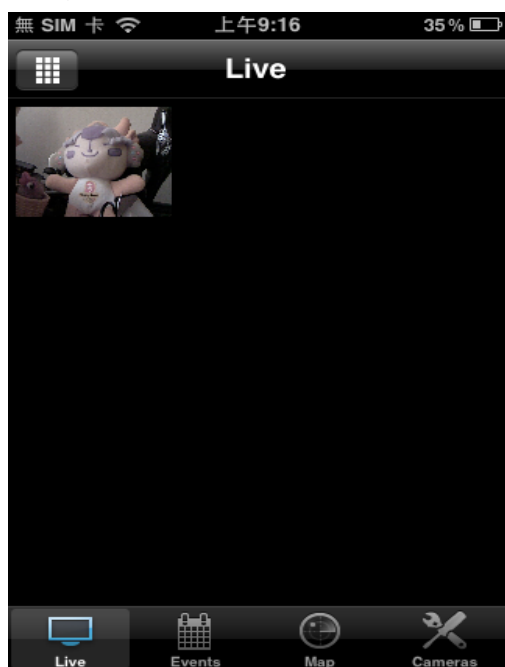

You can click this button repeatedly to switch 1 camera / 4 cameras / 12 cameras view.

(5) You can manage network cameras in 'Cameras' list. To add a new network camera, click 'Add New Camera'.



(6) EdiView will search for network camera on your local area network, and list all network cameras found here.

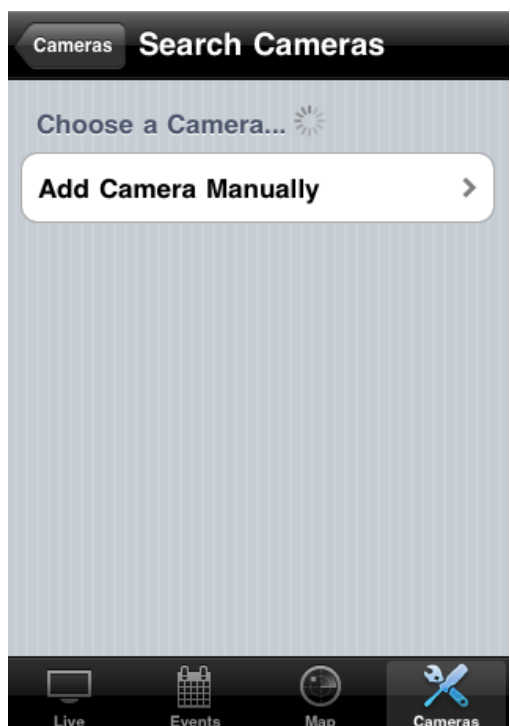

To add an network camera manually or add an network camera on Internet, click 'Add Camera Manually' button.

(7) In this page, you can input network camera's parameters manually

Parameter	Value
Camera Type	IP
Camera Name	IC-BD3C08
IP	192.168.98.103
Port	80
Username	admin
Password	••••
Brightness	1 >
Saturation	4 >
Sharpness	5 >

Camera Type: Switch operating mode between Cloud and IP. In cloud mode you have to input Cloud ID**; In IP mode you have to input IP address or host name of network camera.

Camera Name: You can define a name for this network camera to help you to remember the purpose / location of this network camera.

IP: Input network camera's IP address or host name.

Port: Input network camera's port number, generally it's '80'.

User Name: Input the user name of network camera. Default user name is 'admin'

Password: Input the password of network camera. Default user name is '1234'

(8) You can also setup video parameters of this network camera.

The screenshot shows a configuration window for a network camera with the title 'IC-BD3C08'. At the top left is a 'Cancel' button and at the top right is a 'Done' button. The settings are organized into two sections. The first section contains four fields: 'IP' with the value '192.168.98.103', 'Port' with '80', 'Username' with 'admin', and 'Password' with four black dots. The second section contains five settings, each with a value and a right-pointing arrow: 'Brightness' (1), 'Saturation' (4), 'Sharpness' (5), 'Video Quality' (Normal), and 'Tilt Speed' (3).

Parameter	Value
IP	192.168.98.103
Port	80
Username	admin
Password	••••
Brightness	1 >
Saturation	4 >
Sharpness	5 >
Video Quality	Normal >
Tilt Speed	3 >

Brightness: Select video brightness (1 to 5, darkest to brightest).

Saturation: Select video saturation (1 to 5, lowest to highest).

Sharpness: Select video sharpness (1 to 5, lowest to highest).

Video Quality: (Highest to Lowest, select a lower video quality will help when network speed is slow).

Tilt Speed: Select camera pan & tilt movement speed. Click 'Done' to save changes

(9) To delete an existing IP camera, click 'Edit' button. Click  of the IP camera you wish to delete



(10) Click 'Delete' button to delete IP camera



(11) Now you can back to 'Live' menu, if you see a snapshot appear, it indicates the network camera is correctly configured.

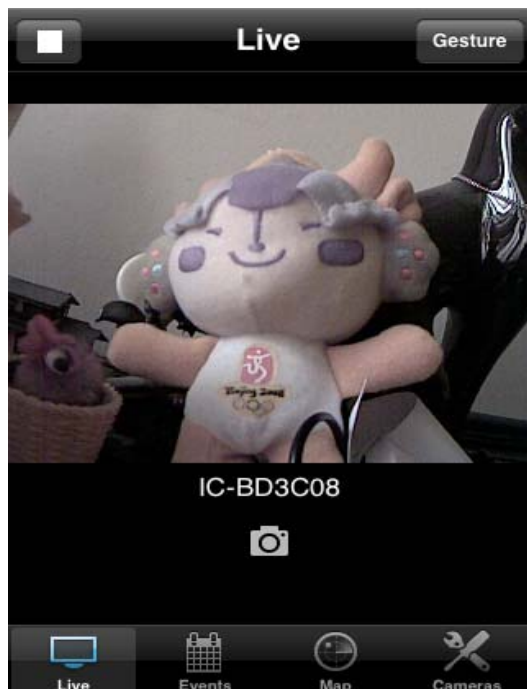

Click snapshot picture to enlarge video view

(12) If network camera you connected supports pan/tilt control, you can click the button on the upper-right corner to switch to 'Gesture' mode and use your finger to slide on the live image view, and network camera will move as your finger slides

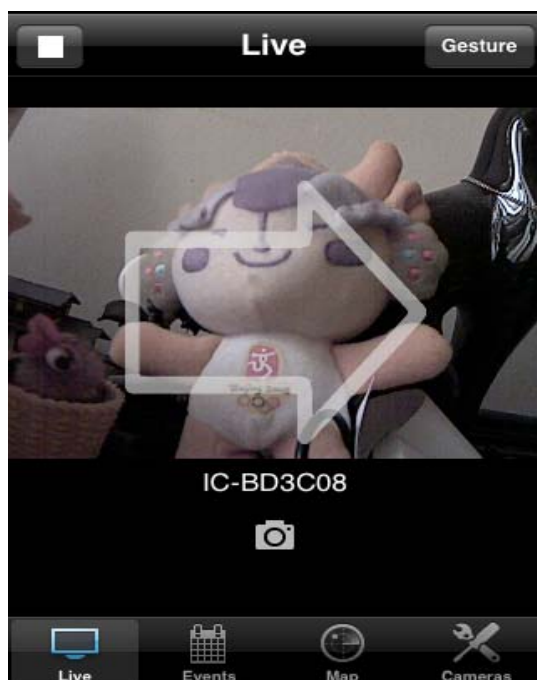

A white arrow will also appear to indicate the direction of camera movement.





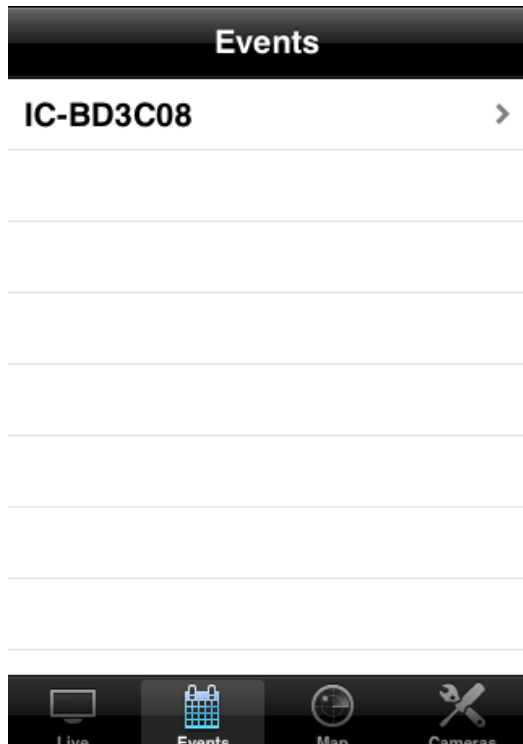

Please note: If the button appears on upper-right corner shows 'Switch', you can't move camera.

(13) To view events (motions detected by network camera), click 'Events' button below in network camera's live view



All network cameras will be listed and you can choose one to see its events list.

(14) All events of selected network camera will be listed here. You can click an event to see enlarged photo.

Events		IC-BD3C08	
	2011/1/1	8:01:51	
	2011/1/1	8:01:59	
	2011/1/1	8:02:22	
	2011/1/1	8:02:27	
	2011/1/1	8:02:41	

(15) Event's snapshot and event date / time will be displayed. Click the button with network camera's name (upper-left corner) to go back.

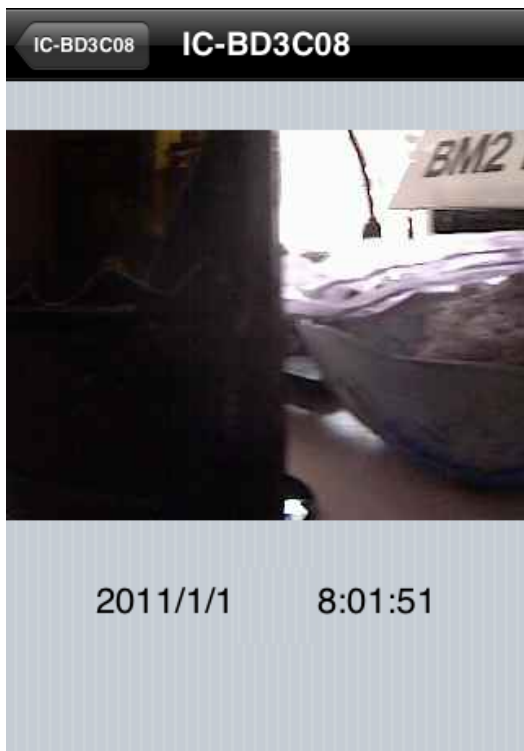

(16) You can use this function to mark your network camera on Google map, so you can locate them and remember their physical location easily.



Please note that you need active Internet connection to show map on your iPhone. Click 'Map' button at the bottom of your iPhone to access Map menu.

(17) Google map will be shown on your iPhone, and it will attempt to locate your current location by GPS and network.



If you're using your iPhone indoors, your iPhone may fail to locate your location. You can still use your finger to drag the map and find your current location manually.

If the network camera you're about to mark on the map does not locate at your current location, you can also use your finger to drag the map and find the location where your network camera is installed.

A red pin indicating the location of network camera will be placed at the center of map.

(18) When you found the location where network camera is installed, click 'Locate' button located at upper-right corner of your iPhone, and a camera list will be shown

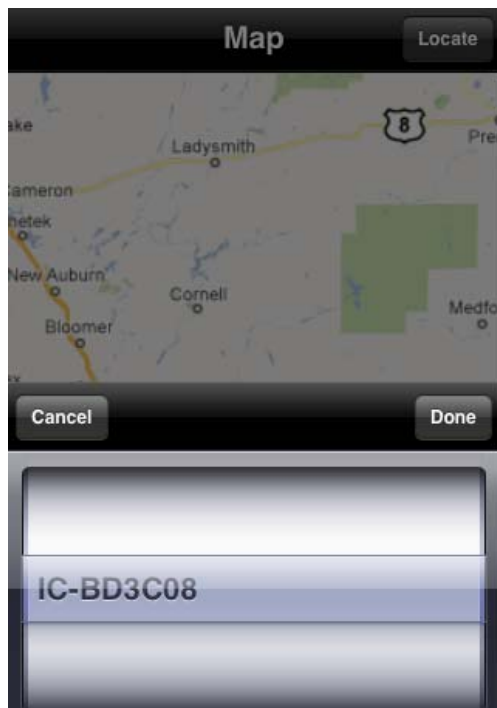

Select the network camera you wish to mark on the map, and click 'Done' when done.

4.2 Android App installation

(1) To install Ediview application, launch 'Market'. (In your Android device's 'All apps' menu)

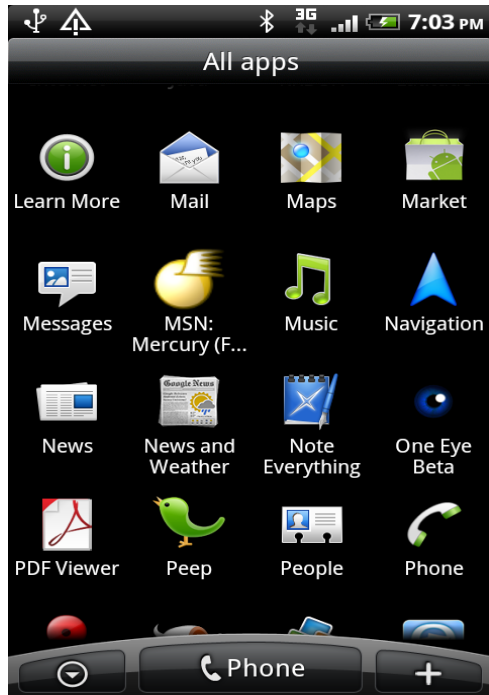

(2) Click magnifier icon at upper-right corner of Android market, and input 'Ediview' in search field

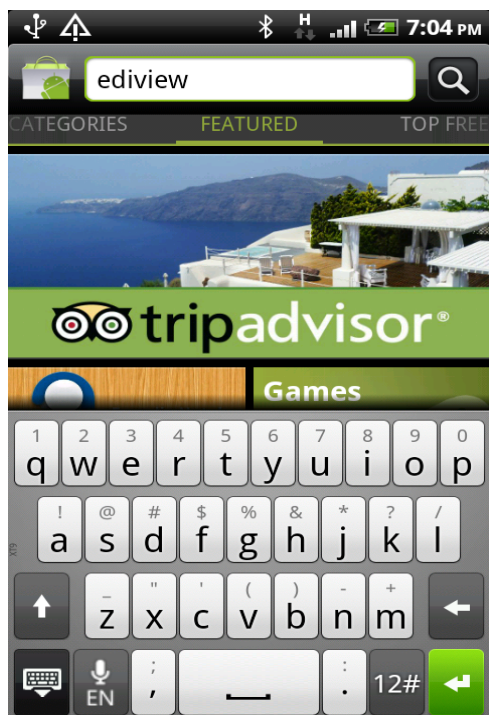

(3) You should be able to find Ediview utility (If not, please check spelling), and click 'Download' to download and install Ediview

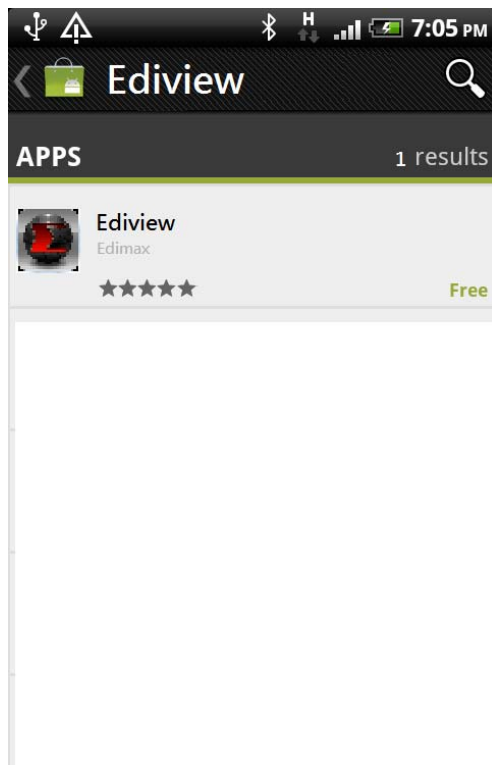

(4) Android will prompt you to confirm installation, please click 'Install' button below to start installation

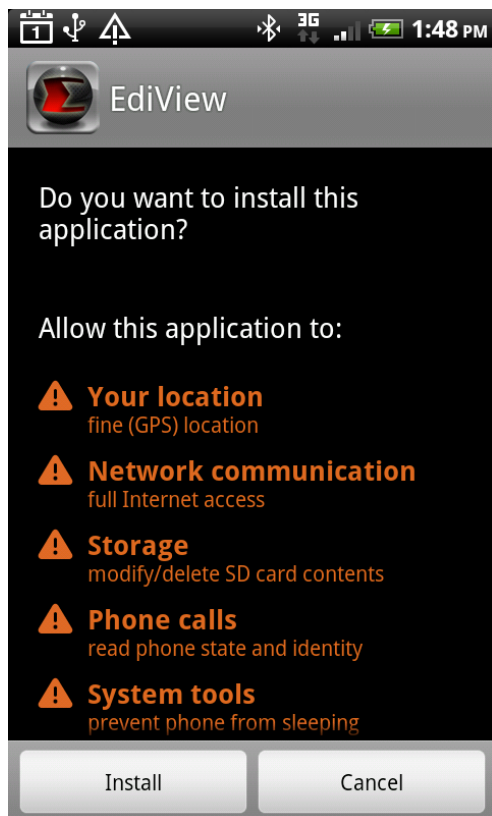

(5) Please be patient while EdiView is being installed.

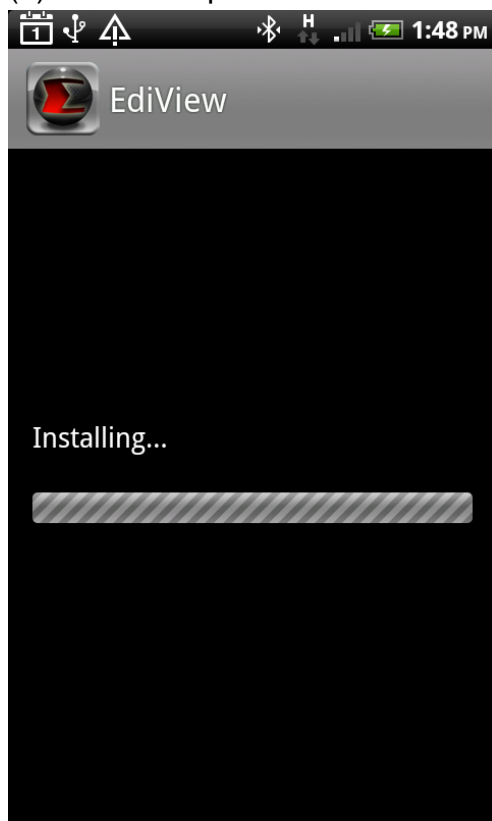

(6) When EdiView utility is successfully installed, you'll see this message. Click 'Open' to launch EdiView utility now, or click 'Complete' to launch EdiView utility later

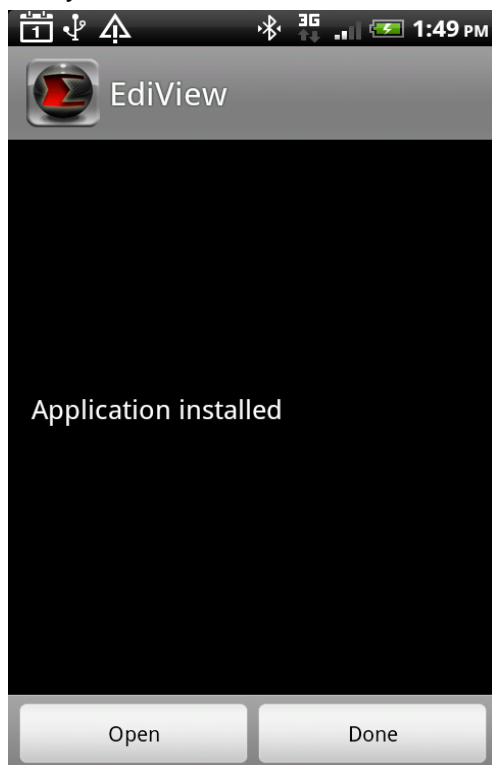

(7) You can launch EdiView by clicking 'EdiView' icon in 'All Applications

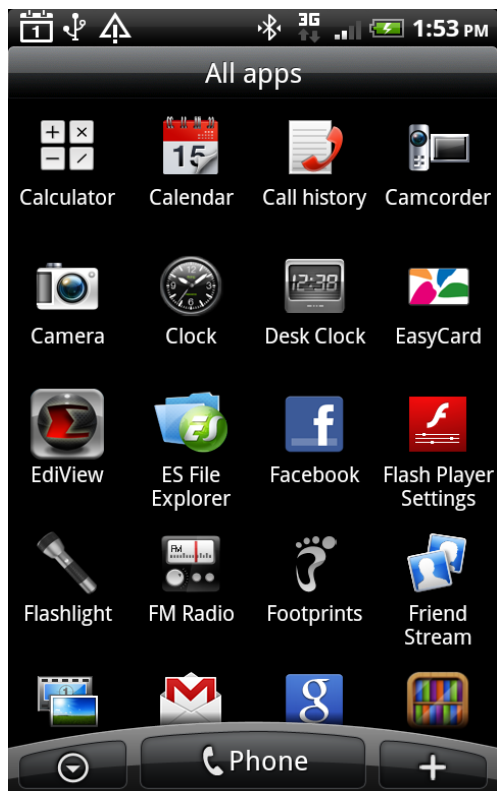

(8) When you launch EdiView, it will search for all Edimax network cameras on your network. Please make sure you're connected to wireless access point if your Edimax network camera is located on your local area network.



If you want to add a Ediamx network camera on Internet, please click 'Manually' button to abort and setup network camera manually

(9) In this page, you can input network camera's parameters manually

Name: You can define a name for this network camera to help you to remember the purpose / location of this network camera

Cloud / IP Mode Switch: Click this button to switch operating mode between Cloud and IP. In cloud mode you have to input Cloud ID**; In IP mode you have to input IP address or host name of network camera

User Name: Input the user name of network camera. Default user name is 'admin'

Password: Input the password of network camera. Default user name is '1234'

Click 'Add' to add a new network camera with parameters listed above.

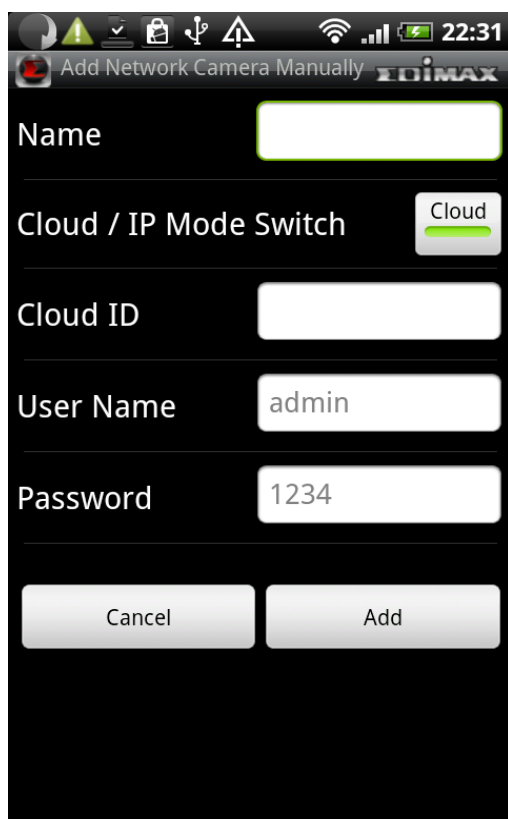

The screenshot shows a mobile application interface for adding a network camera manually. The title bar at the top reads "Add Network Camera Manually" and "EDIMAX". The interface includes the following elements:

- Name:** An empty text input field.
- Cloud / IP Mode Switch:** A toggle switch currently set to "Cloud".
- Cloud ID:** An empty text input field.
- User Name:** A text input field containing the default value "admin".
- Password:** A text input field containing the default value "1234".
- Buttons:** Two buttons at the bottom: "Cancel" and "Add".

(10) When an network camera has been added successfully, you'll see it appear in EdiView utility's camera list

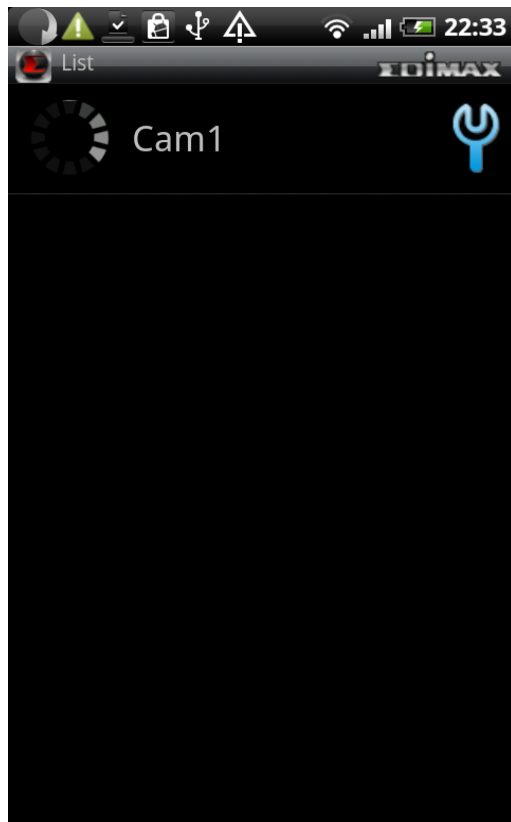

Please repeat last step to add more network cameras you wish to connect. To repeat last step, press 'Menu' key on your Android device and click 'Add' button

(11) If the network camera is connected, you'll see a picture appear. Click the Picture to view live image

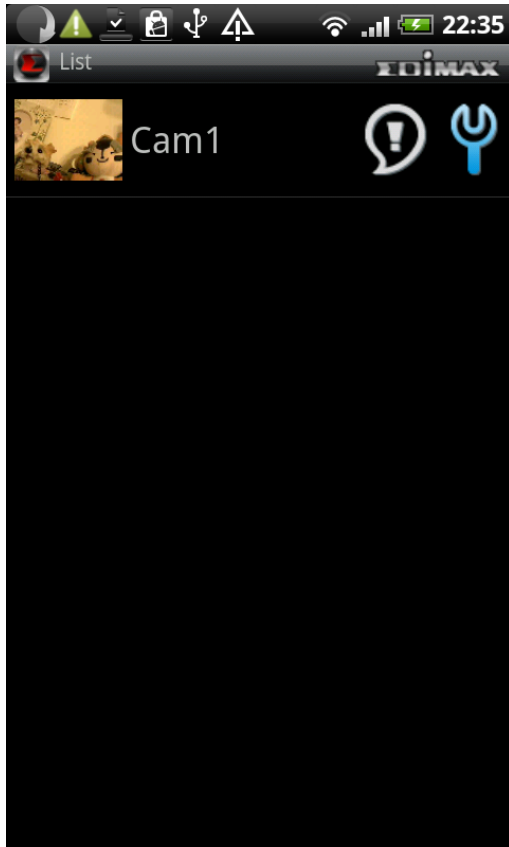



If there are new events available, click  icon

To configure network camera's parameters, click  icon

(12) When you click an network camera in camera list, you'll see its live image Like this. You can hold your Android device horizontally to enlarge network camera's live image view.

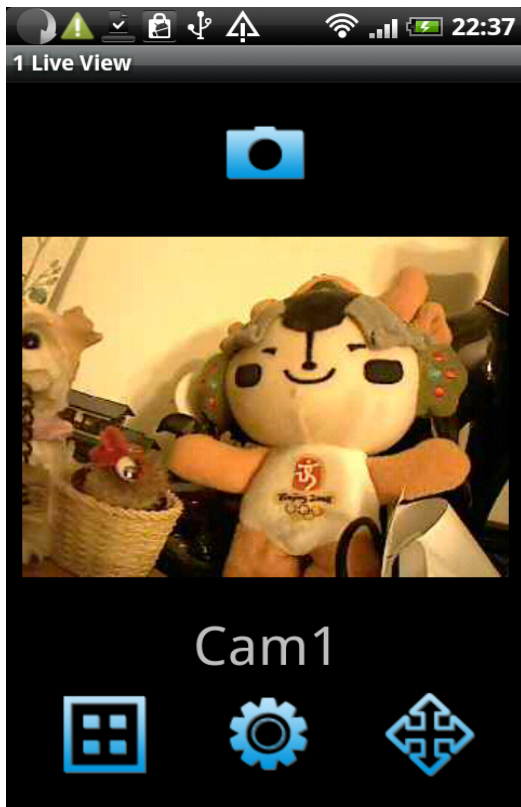
If the network camera you connected supports Pan & Tilt, you can click  button and use your finger to slide on the live image to the direction you wish to move.



(13) To take a snapshot of current live image and save it on your Android device, click  button. You'll see 'Save Snapshot' message appear, which indicates a snapshot has been taken.

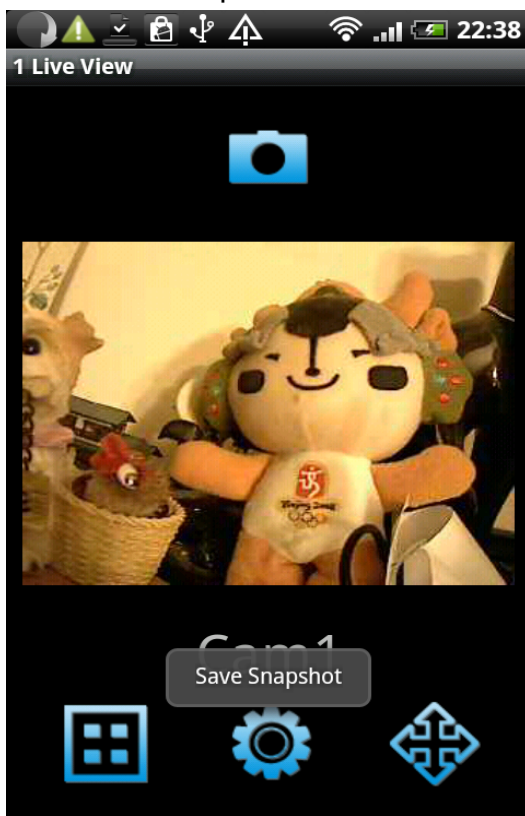

(14) If you have more than 1 network cameras, you can click  button and you can see the image of up to 4 network cameras at the same time; Click on the camera's image to enlarge it

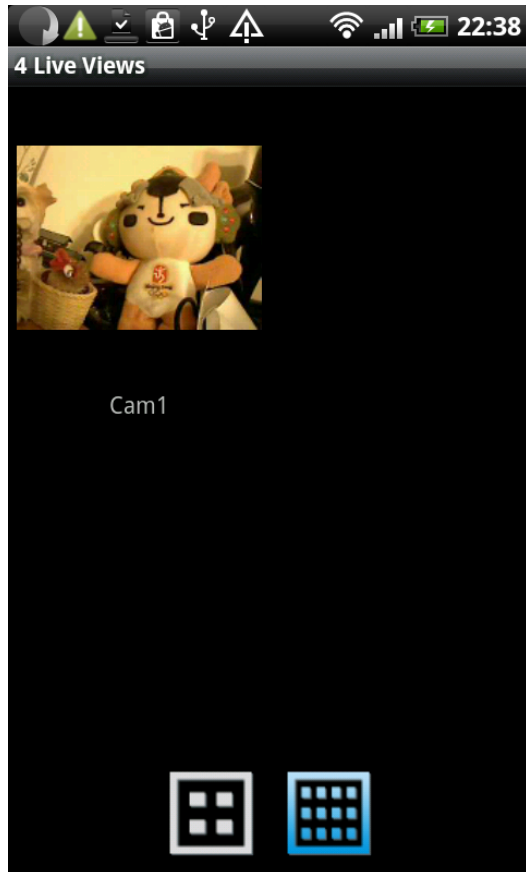

You can also click  button to see up to 12 network cameras at the same time.

(15) To configure the video display parameters of this network camera, click  button, and you can drag the slide bar to configure parameters:

Brightness: Configure video brightness

Saturation: Configure video saturation.

Sharpness: Configure video sharpness.

Video Quality: Configure video quality by setting a lower (left) or higher (right) image quality. When network speed is slow, using a lower video quality will help.

Pan & Tilt speed: configure the camera moving speed when you use pan / tilt function

Click 'Done' button when you finish, or click 'Cancel' to abort. You'll see the result after you click Done'.

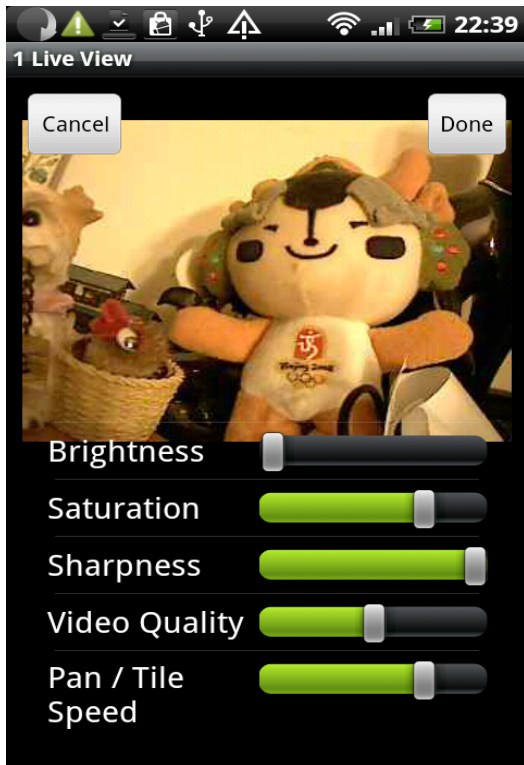

(16) When a new event (movement) has been detected by network camera, you'll see  icon appear in network camera list. You can click it to see events.

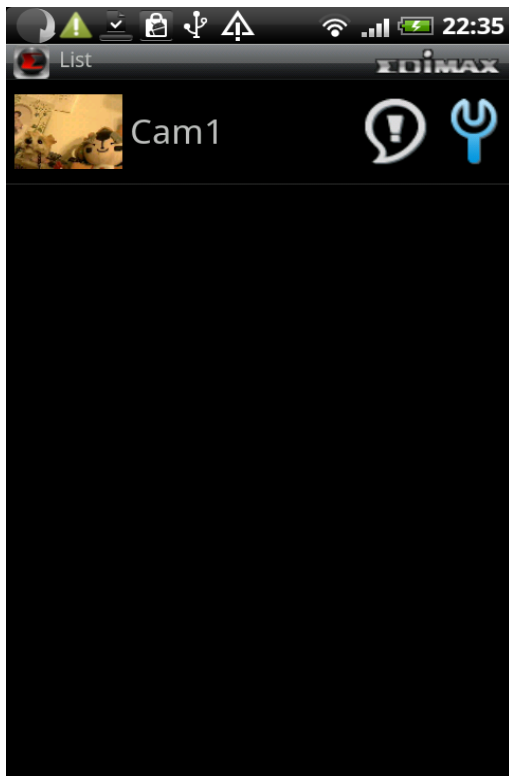

(17) All events will be displayed here, with the time which triggered this event.
Click on the event to see enlarged picture

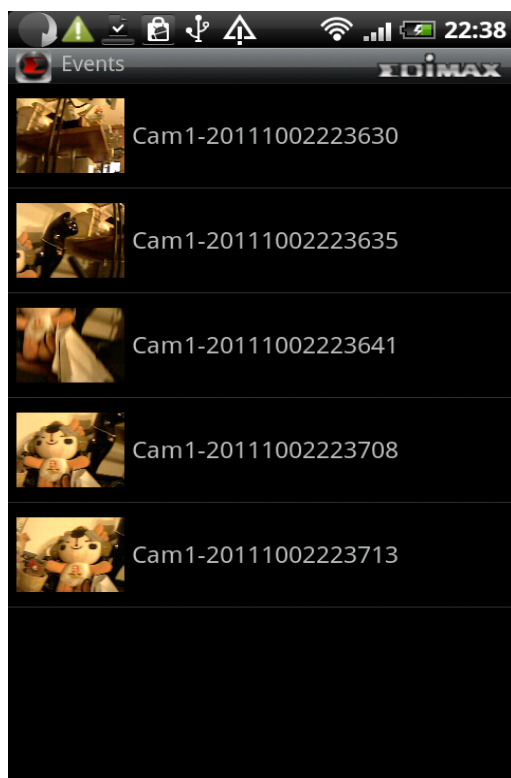

(18) The image of this event will be displayed with the time triggered this event.
To see enlarged picture, hold your Android device horizontally

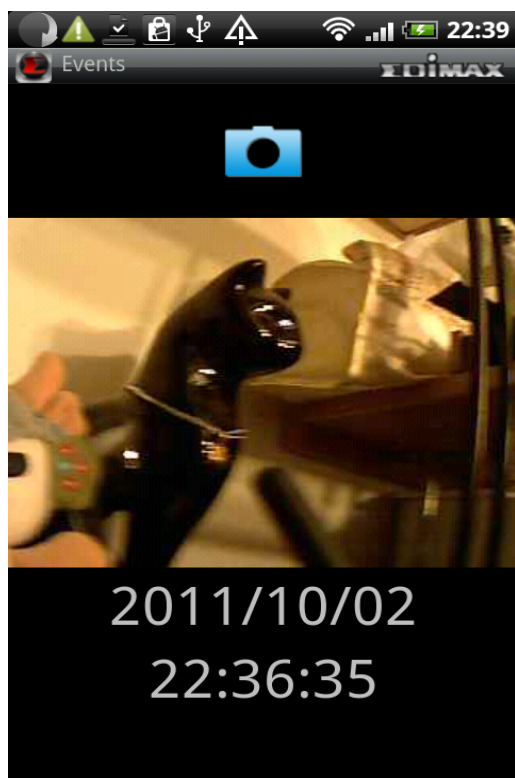

(19) To save a snapshot of this event, click  button. You'll see 'Saved event image successfully' message to prompt you that image has been saved successfully.

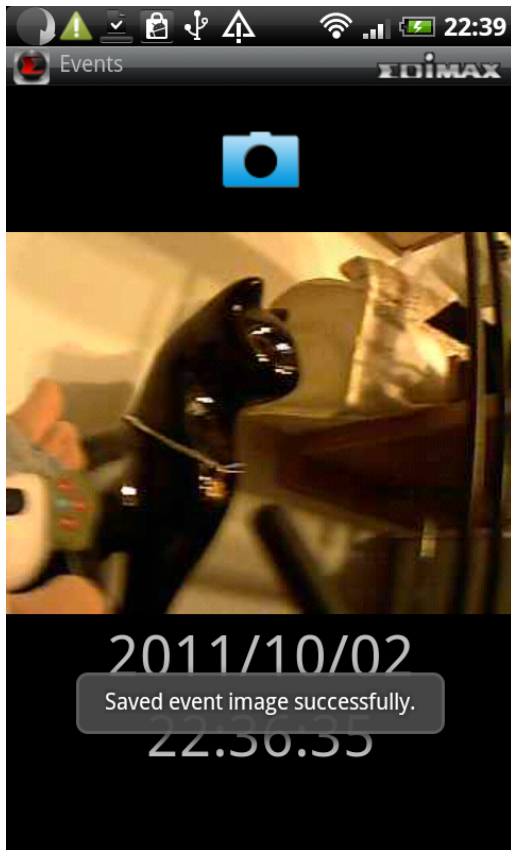

(20) When you're in camera list, press 'Menu' button on your Android device. A menu will appear on the bottom of EdiView utility.



Live See live images of network cameras



Map Use google map to locate network cameras



Add Add a new network camera



Refresh Reload network camera list

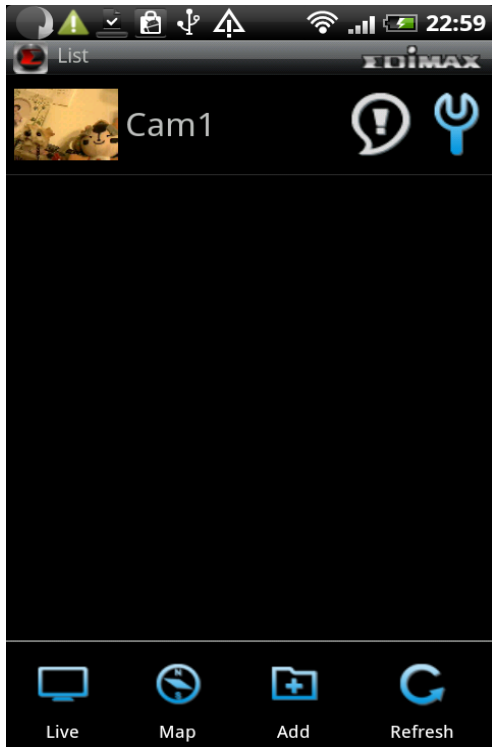

(21) You can use this function to mark your network camera on Google map, so you can locate them and remember their physical location easily. Please note that you need active Internet connection to show map on your Android device.

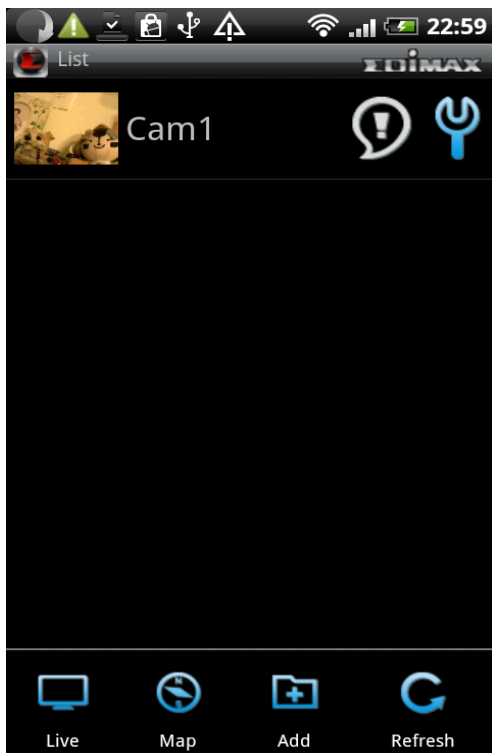

Click 'Map' button at the bottom of your Android device to access Map menu

(22) Google map will be shown on your Android device, and it will attempt to locate your current location by GPS and network

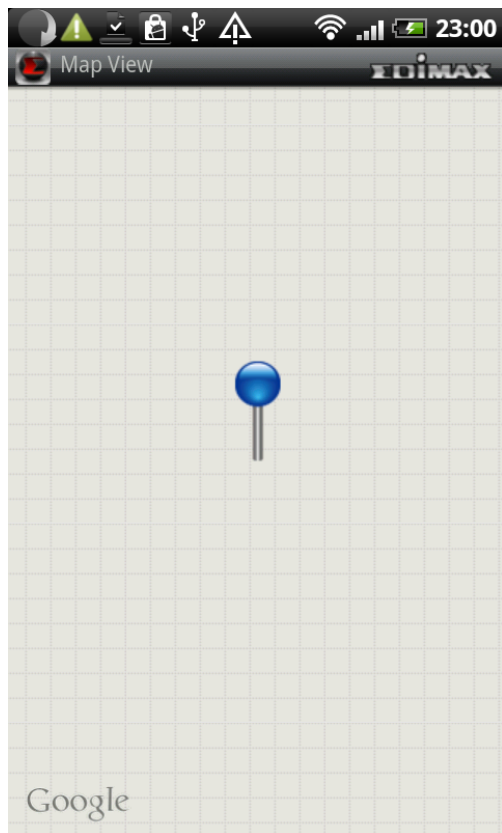

If you're using your Android device indoor, your A may fail to locate your location. You can still use your finger to drag the map and find your current location manually.

If the network camera you're about to mark on the map does not locate at your current location, you can also use your finger to drag the map and find the location where your network camera is installed

A blue pin indicating the location of network camera will be placed at the center of map.

(23) When you found the location where network camera is installed, press 'Menu' button on your Android device and click 'Locate' button and a camera list will be shown. Select the network camera you wish to mark on the map.

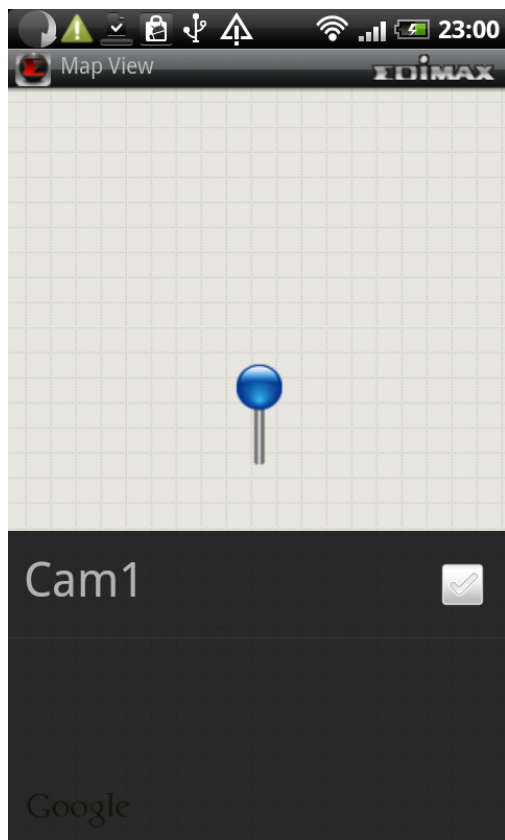

4.3 Web browser installation

Please make sure your web browser supports JAVA first. If your web browser does not support JAVA, you can install JAVA from website: www.java.com and get JAVA software.

(If your web browser does not support JAVA, you'll see this message when you try to use JAVA browser)

 Java Applet is not Supported by your Browser. Please visit <http://www.java.com/> to download.

(1) If you're not login Windows as system administrator, please use system administrator to launch Internet Explorer. To do so, right-click Internet Explorer icon and click 'Run as administrator'.

NOTE: You must use 32-bit Internet Explorer!

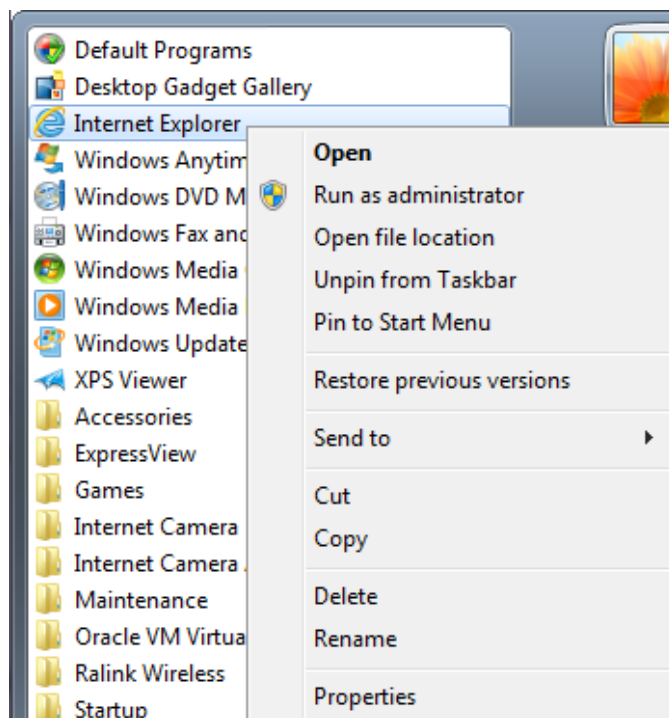

(2) Input the following web address in your web browser's address bar:
"XXXXXXXXXXXXX.myedimax.com".

Where XXXXXXXXXXXXX is the 12 characters of your Edimax network camera's MAC address. If you don't know the MAC address of your Edimax IP camera, you can log onto network camera's web configuration menu and click "System" -> "System Information" -> "Status"->"LAN" to see its MAC address.

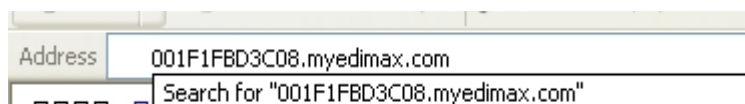

(3) If you see this message, click 'Run' to continue

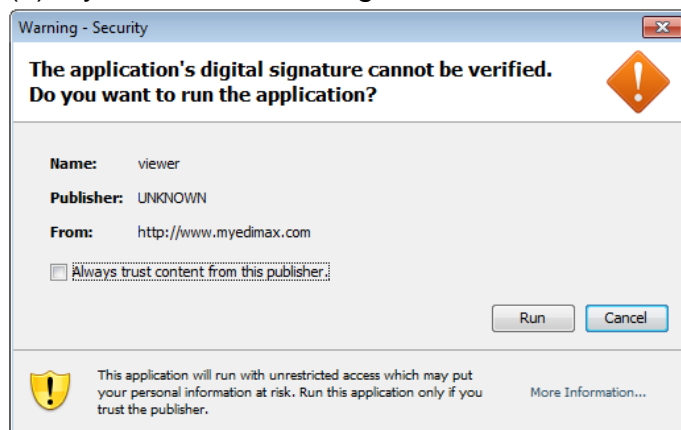

(4) Please wait while JAVA loads, and please input your network camera's password to login. Default password is '1234'. Click 'OK' to continue.



(5) You should be able to see the image of network camera now.

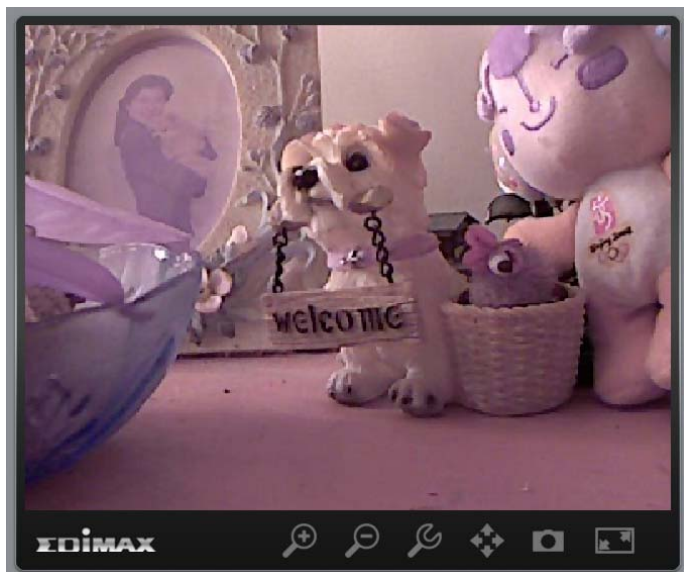

You can click function buttons below.



Enlarge / reduce image size



Click + or – button to enlarge or reduce image size, this is very useful when you want to see details of certain object in the image.



Configure network camera



Click this button to display network camera configuration menu and you can change the parameters of IP camera. Click 'Apply' to save changes or click 'Cancel' to discard changes.

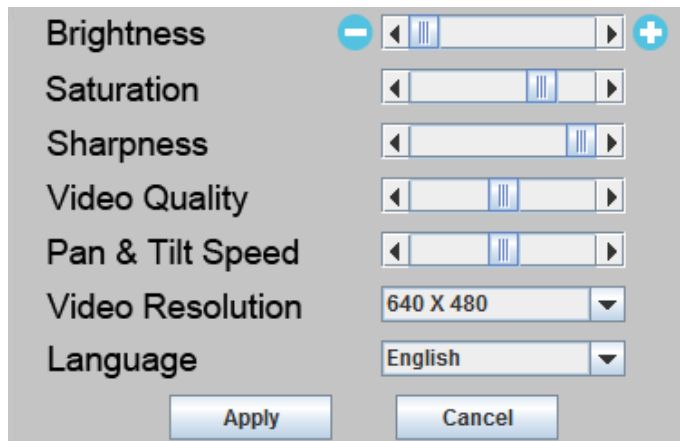

Pan-tilt control



Click this button and a set of arrow will be shown on the image. Click the arrow to move network camera to the direction indicated by the arrow.

Click circle located in the center or arrow set to return network camera to 'Home' (original) position. If you no longer need to use pan-tilt function, click this button again

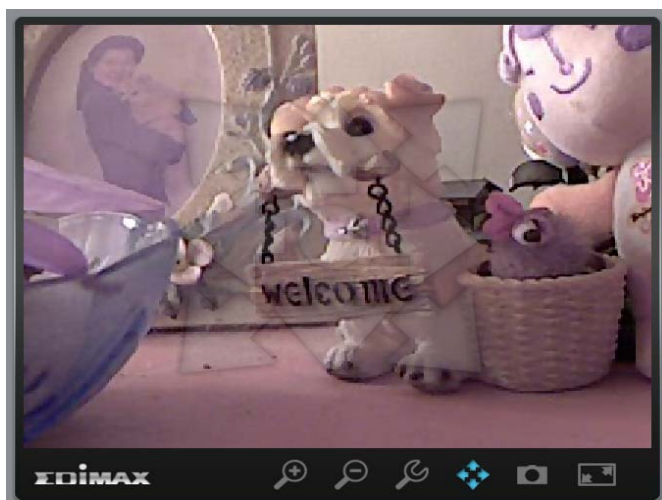

Snapshot



Click this button to take a snapshot of current image and save on your computer's hard drive.

You'll be prompted to select a folder on your computer.

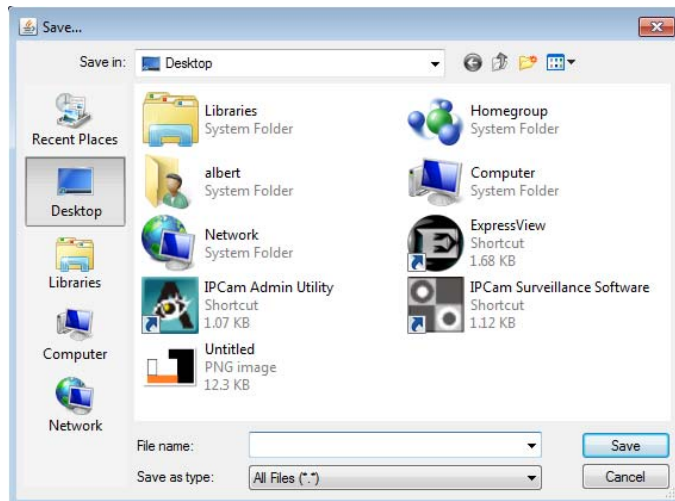

Full-screen view



Click this button to enlarge image view to full-screen size, all function buttons will disappear to maximize display area. Click anywhere in the image to return to normal display mode.



Chapter V: Appendix

5.1 Specifications

Max Resolution: 1280 x 1024 pixels

Sensor: 1.3Mega pixels 1/4" color CMOS sensor

Gain control: Automatic

Exposure: Automatic

White Balance: Automatic

Image (Video Setting)

Image compression: MJPEG/MPEG4/H.264 Image Video

Digital 24-bit Color

Frame rate: 10-15fps@SXGA, XGA, 30fps@QVGA, 20fps@VGA

Video resolution: MJPG&H.264: 1280x1024, 640x480, 320x240

MPEG4: 1024x768, 640x480, 320x240

System Hardware

LAN Connector: One RJ-45 port to connect to 10/100Mbps Ethernet

Wireless: IEEE 802.11b/g/n (*Wireless Model Only)

LED Indicator: Power/Audio/LAN/WLAN for wired and wireless model

Power/Audio/ACT/LAN for POE model

HTTP/Utility

Includes easy-to-find and surveillance utility

Provides Web based Management

View multiple cameras simultaneously on PC surveillance software up to 16 cameras at a time

Supports 16 additional user accounts for viewing camera

Auto sending Snap Shot or video by E-mail or FTP

Support NO-IP DNS and UPnP functions

Supports Windows 2000/XP/Vista/Win7

Firmware Upgradeable

EMI & Safety

FCC, CE class B

5.2 How to apply for a free DNS account at <http://www.no-ip.com>

It's very likely your IP address (the Internet location) keeps changing every a couple of hours or every day depending on your ISP's policy. Therefore, as shown in the following figure, you may be assigned with an IP address, "61.61.61.1" hours ago, and now with a new IP address, "72.72.72.1". This means the router at "My-home" can be found at <http://61.61.61.1> over the Internet is no longer available after a few hours. To find out the new location (IP address) of the router at My home over the Internet, you need to login to the router, checking the new IP address. However, this is not a workable solution.

To overcome this problem, an Internet service called NO-IP DNS is designed to help you trace the log of the changing IP address linking with a web site address (URL). As shown in the following figure, one PC called DNS server keeps revising the record "your-name.no-ip.org vs 61.61.61.1" in its internal DNS directory. It ends up entering <http://your-name.no-ip.org> in the iPhone can find out the 2 network camera at My-home.

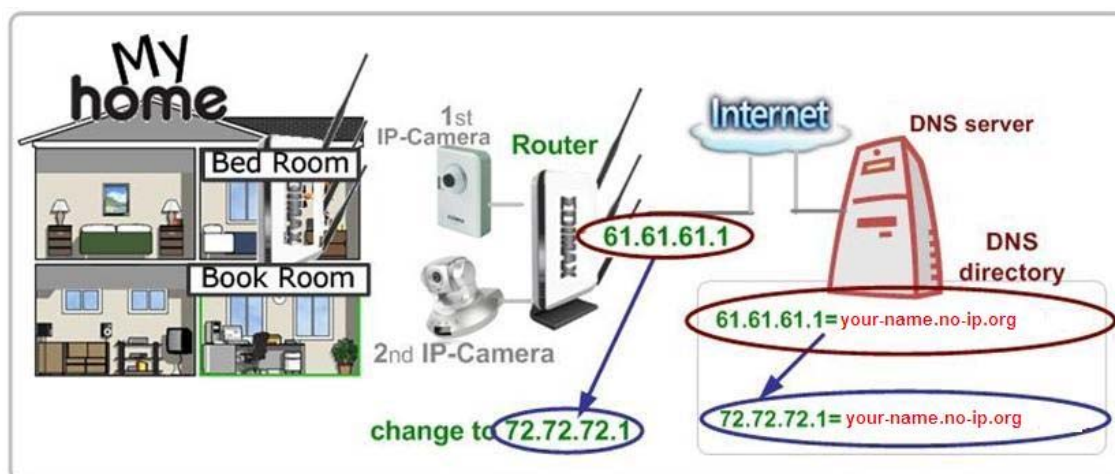

The following are steps to apply for an account named "your-name.no-ip.org" in the <http://www.no-ip.com> and how this account is configured into Edimax router.

Note: <http://www.no-ip.com> is not a branch or affiliate of Edimax. No commercial relation is involved between these 2 companies. The related service offered in the <http://www.no-ip.com> is for free for a specific time. However, Edimax does not guarantee this service.

First, go to <http://www.no-ip.com> and apply for an account.

And follow the steps:

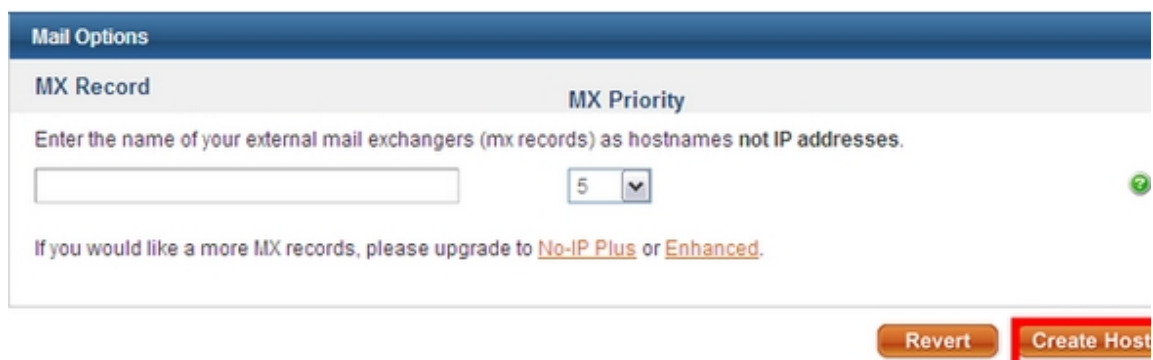
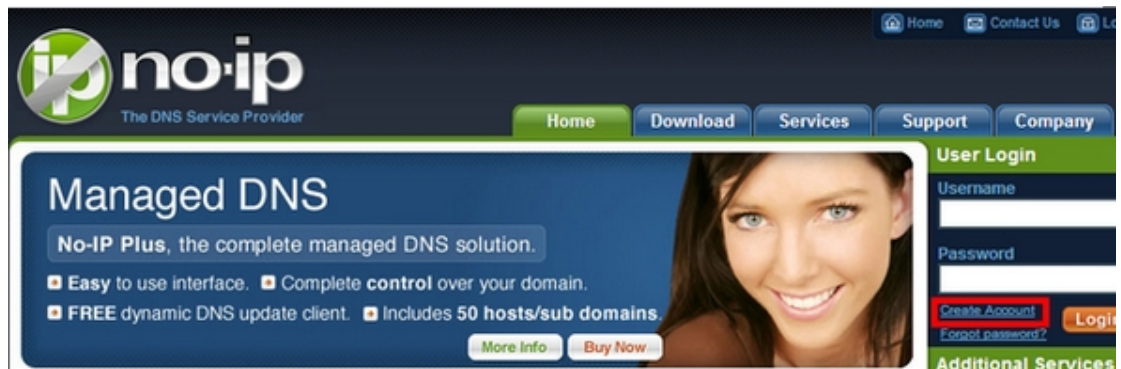

Now, you could locate your home network camera using <http://your-name.no-ip.org>

5.3 Troubleshooting

If the network camera is not working properly, before you contact the dealer of purchase for help, please check the troubleshooting list here, this may help you to solve the problem by yourself and therefore saves your valuable time.

Scenario	Possible Solution
I can not connect to network camera	<p>a. Please confirm the IP address setting of the computer you're using. If they're not in the same subnet, they will not be able to communicate with each other.</p> <p>b. Please make the IP address you used to connect to the network camera is correct.</p> <p>c. If you forget the IP address of the network camera, you will have to reset it to factory default value (which is 192.168.2.3) by pressing 'reset' button at the bottom of the network camera. You'll need a pen or pin to be able to press the reset button. Press and hold reset button for 5 seconds, then try to connect to the network camera with IP address '192.168.2.3' again.</p> <p>d. Please make sure network camera is correctly powered (the 'Power' LED should be on).</p> <p>e. If you're trying to connect to the network camera from Internet, please make sure the port that network camera uses (Video and HTTP port, see section 2.3.1) is not blocked by firewall or other software / hardware.</p> <p>f. Contact dealer of purchase for help, if above solutions do not work.</p>
Image refreshes very slow	<p>a. Try a higher frame rate setting, if it's not 30.</p> <p>b. Try a lower resolution.</p>

	<p>c. If you're connecting this camera from Internet, it could be caused by a slow Internet connection, and it's not a problem caused by camera. However, when the network connection is slow, you should use lower frame rate / resolution.</p> <p>d. Adjust the antenna if you're using wireless connection. The antenna should be perpendicular to the ground to get best reception, and the distance between network camera and computer / wireless access point should not be too far.</p> <p>e. Try to adjust 'MTU' setting if you're using PPPoE to connect to Internet. Ask your ISP or network administrator for detailed instruction.</p>
Network camera is not responding	<p>a. Is the network cable or wireless connection disconnected? Please check it.</p> <p>b. Unplug the power adapter from wall socket and plug it in again after 10 seconds, then try to connect to the network camera again.</p> <p>c. If network camera is correctly powered ('Power' LED is on), but you still can not connect to the camera when you're sure that IP address is correct, please contact dealer of purchase for help).</p>
Image is fuzzy	<p>a. Adjust the focus ring on the camera until the image becomes clear.</p> <p>b. Use a soft cloth to clean the lens on the camera. You can use cloth with water, but <i>DO NOT</i> use alcohol or other chemical solution.</p> <p>c. Try to adjust brightness setting.</p> <p>d. If there's any light at the place where network</p>

	camera is located, switch it on and see if image looks better.
I set the network camera to send image by Email or FTP, but nothing is received	<p>a. If the image is send by Email, please make sure it's not blocked by any anti-spam mechanism.</p> <p>b. Please make sure you have enough permission for FTP uploading (You can try this by clicking 'Upload a test file' button).</p> <p>c. Make sure the user name and / or password of SMTP server is correct, if your SMTP server requires authentication (You can try this by click 'Send a test Email' button).</p> <p>d. Please check log, if FTP upload or Email sending is failed, it will be logged, and this may give you some clue on how to solve the problem.</p> <p>e. Change the threshold to a more sensitive setting.</p>
I heard strange sound when I use pan / tilt function	<p>a. Please check if anything jams the camera, remove it.</p> <p>a. If the camera does not respond to you when you're trying to use pan / tilt function, the servo motor inside the camera may dead. Please return the camera to the dealer of purchase and ask for help.</p>
Nothing is heard at the camera side when I use 'Speak to IPCam' function	An external speaker is required to playback the voice received at computer side.



EDIMAX
NETWORKING PEOPLE TOGETHER

Edimax Technology Co., Ltd

6F., No.3, Wu-Chuan 3rd Road, Wu-Gu,
New Taipei City, Taiwan

Edimax Technology Europe B.V.

Nijverheidsweg 25 5683 CJ Best
The Netherlands

Edimax Computer Company

3350 Scott Blvd., Bldg.15 Santa Clara,
CA 95054, USA